



MTD Silent Series

MIXED FLOW IN-LINE DUCT FAN



Mixed Flow In-Line Duct Fan – MTD Silent Series

KRUGER

MTD Silent 100/2~200/2



Low profile "Mixed-flow" fans with sound-absorbent insulation. Extremely quiet.

General

- Manufactured in plastic material, with a specifically designed internal skin to direct the sound waves in the right angle for them to be captured by the sound-absorbent material.
- Fitted with rubber gaskets on the inlet and outlet to absorb vibrations, a body that can be dismantled.
- Connection box can be rotated 360°, to facilitate easy connection of the power cable.
- The low profile of the MTD Silent fans makes them the most effective solution for installations where the space of installation is limited such as false ceilings.

Motors

- Speed controllable 230V -50Hz motor, of two speed motors. IP 44.
- Motors are Class B, with ball bearings and safety thermal overload protection.

Additional information

- The models offer solutions to ventilation problems, especially in places where people work and low sound level is required.

MTD Silent 250~315



Low profile "Mixed-flow" fans with sound-absorbent insulation. Extremely quiet.

General

- Constructed from sheet steel with epoxy polyester paint, acoustic insulation(MO) glass fibre, within outer shell.
- Aerodynamic inlet to improve air flow and reduce sound. Detachable fan unit without demounting duct connections.
- Low profile fans MTD Silent 250 and MTD Silent 315 are ideal for installations where space is very small, as in false ceilings.

Motors

- IP 44. External terminal box IP 55.
- Removable fan body with two speed motor, single phase 230V -50/60 Hz speed controllable, Class F, external rotor aluminium motor with capacitor and thermal protection.

Technical Data

Model	Max Q m ³ /h	Power W	Phase	N° Pole	Max Amp	Maximum Operating Temp. (° C)	dB (A) at 3m*	RPM	Weight (kg)
MTD Silent 100/2	240 / 200	24 / 18	1	2	0.11 / 0.10	-20 / +40	24 / 19	2200 / 1850	5.40
MTD Silent 125	360 / 300	30 / 22	1	2	0.13 / 0.10	-20 / +40	20 / 19	2250 / 1900	4.94
MTD Silent 160	570 / 430	50 / 44	1	2	0.22 / 0.19	-20 / +60	22 / 17	2500 / 1950	6.00
MTD Silent 200/1	900 / 790	95 / 90	1	2	0.45 / 0.43	-20 / +60	19 / 18	2780 / 2480	8.70
MTD Silent 200/2	1030 / 790	120 / 100	1	2	0.50 / 0.45	-40 / +60	21 / 20	2500 / 2000	8.70
MTD Silent 250	1270 / 1070	197 / 145	1	2	0.83 / 0.61	-40 / +60	35 / 31	2570 / 2190	20.0
MTD Silent 315	1760 / 1500	297 / 191	1	2	1.28 / 0.79	-40 / +60	39 / 33	2680 / 2300	25.0

Dimension

MTD Silent 100/2 ~ 200/2

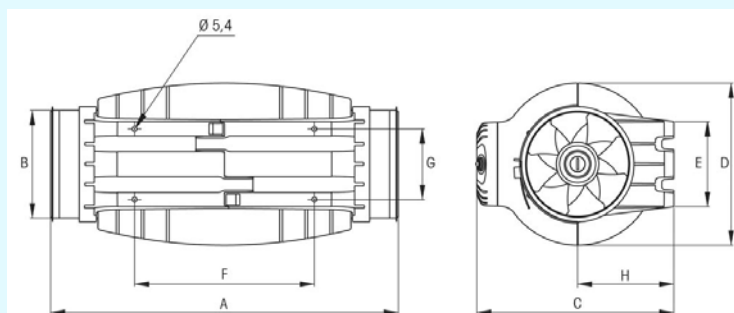

Model	A	ØB	C	ØD	E	F	G	H
MTD Silent 100/2	575	97	252	204	100	250	83	121
MTD Silent 125	462	123	252	204	100	250	83	121
MTD Silent 160	484	147	274	221	116	250	96	134
MTD Silent 200/1	568	198	327	264	145	340	129	164
MTD Silent 200/2	568	198	327	264	145	340	129	164

MTD Silent 250 ~ 315

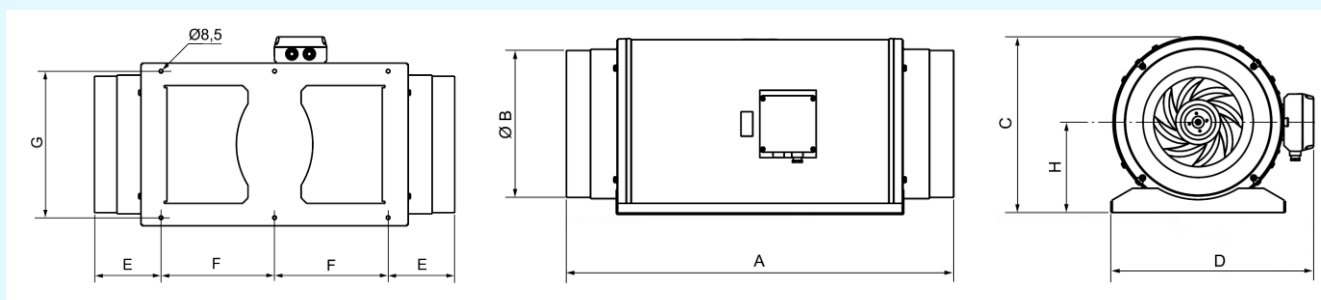

Model	A	B	C	D	E	F	G	H
MTD Silent 250	680	248	331	387	140	200	280	171
MTD Silent 315	825	312	373	432	152	260	335	192

All dimensions in mm.

Accessories



MCA-S

Non-return flaps to be installed at the fan discharge. They prevent heat leakages when the extractor is not operating.



MAR-S

Rectangular Duct Adapters enable connection to rectangular ducting.



MRJ-S

Grilles mounted at the inlet or outlet of the fan, to prevent the entry of any foreign objects that could damage the fan.



MPC-S

Flow detectors designed to correctly measure pressures at the inlet with airflow straightener.

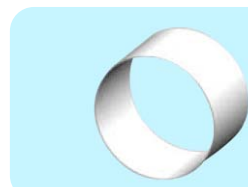

MBR-S

Flanges allowing the coupling of MTD-Silent fans in series.

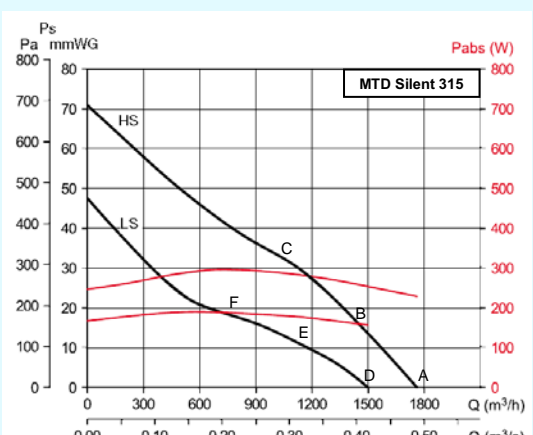
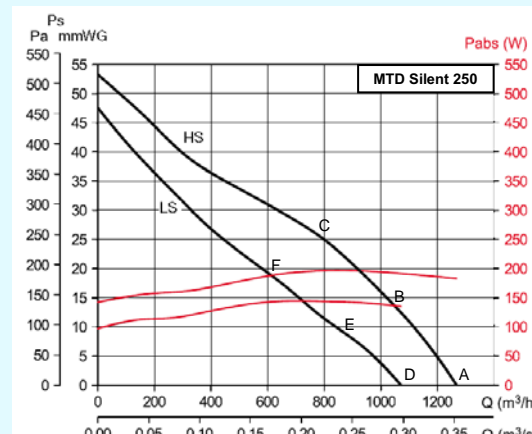
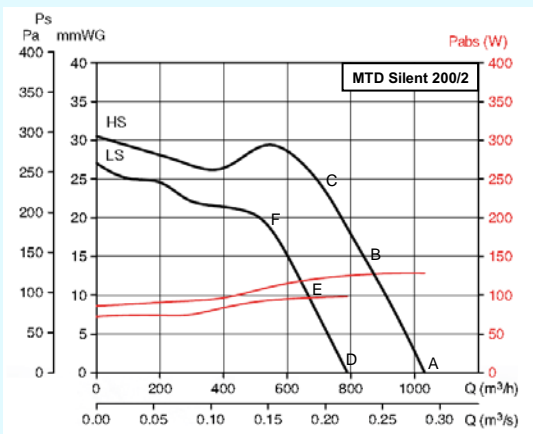
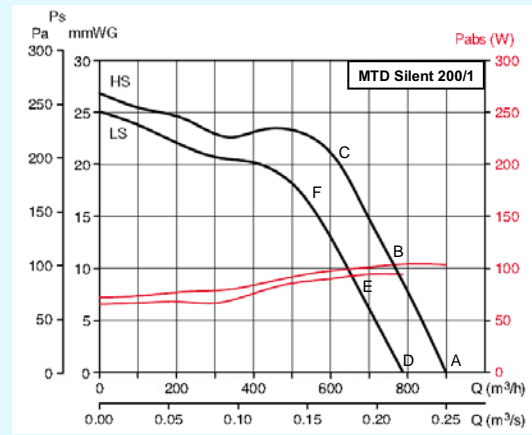
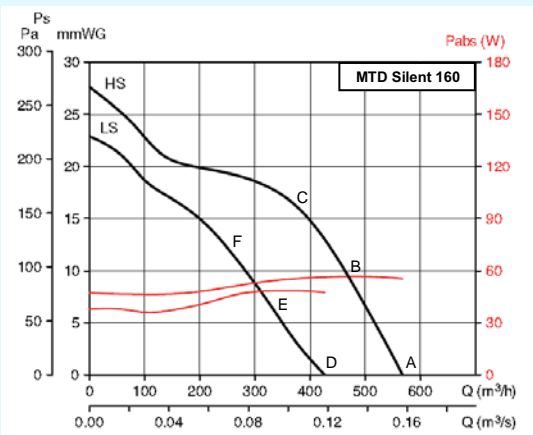
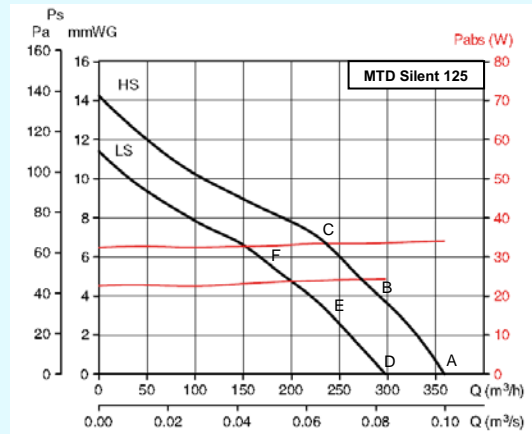
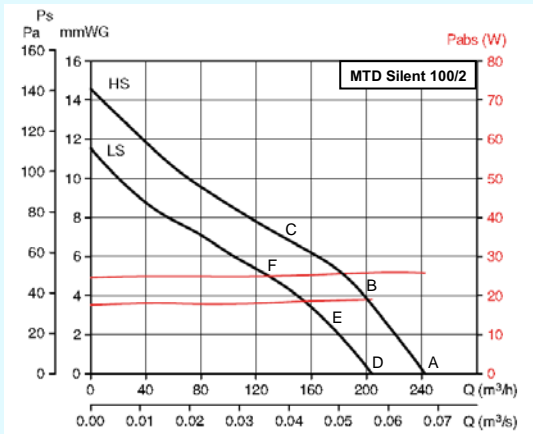

		MTD Silent 250	63	125	250	500	1000	2000	4000	8000	LwA	LpA*
HS	Inlet	A	30	42	60	59	62	61	58	52	67	47
		B	32	43	62	60	61	60	56	51	67	47
		C	36	47	63	60	58	58	55	48	67	47
	Radiated	A	26	31	46	42	55	48	39	38	57	37
		B	28	32	48	43	54	47	37	37	56	36
		C	32	36	49	43	51	45	36	34	54	34
	Outlet	A	33	45	60	68	72	65	54	48	74	54
		B	30	46	61	69	71	63	52	47	74	54
		C	32	51	62	69	67	60	51	44	72	52

		MTD Silent 250	63	125	250	500	1000	2000	4000	8000	LwA	LpA*
LS	Inlet	D	30	40	59	55	59	57	53	47	64	44
		E	35	40	57	56	56	55	51	46	63	43
		F	38	45	59	57	53	53	49	42	63	43
	Radiated	D	24	32	44	39	53	44	34	33	54	34
		E	29	32	42	40	50	43	32	32	52	32
		F	32	37	44	41	47	40	30	28	50	30
	Outlet	D	30	43	58	63	72	59	50	43	73	53
		E	29	44	57	65	66	57	47	41	69	49
		F	32	48	59	65	62	55	45	38	68	48

		MTD Silent 315	63	125	250	500	1000	2000	4000	8000	LwA	LpA*
HS	Inlet	A	34	48	60	63	66	64	59	55	70	50
		B	34	49	63	62	65	64	60	55	70	50
		C	37	56	64	63	63	62	58	52	70	50
	Radiated	A	23	36	44	50	57	54	49	43	60	40
		B	23	37	47	49	56	54	50	43	60	40
		C	26	44	48	50	54	52	48	40	58	38
	Outlet	A	42	54	67	69	73	66	52	49	76	56
		B	38	55	66	67	73	65	51	49	75	55
		C	36	61	68	71	68	62	49	46	74	54

		MTD Silent 315	63	125	250	500	1000	2000	4000	8000	LwA	LpA*
LS	Inlet	D	37	47	59	57	60	58	54	48	65	45
		E	34	47	59	56	58	56	53	47	64	44
		F	32	48	59	55	56	54	51	43	63	43
	Radiated	D	27	40	43	45	52	49	45	37	55	35
		E	24	40	43	44	50	47	44	36	54	34
		F	22	41	43	43	48	45	42	32	52	32
	Outlet	D	34	52	62	63	67	60	47	43	70	50
		E	34	53	60	62	66	58	44	41	69	49
		F	31	55	64	61	61	55	41	37	68	48

- The sound levels shown in these tables are sound power levels at the discharge, radiated and inlet, in dB(A) for frequency ranges at points of the curve: (A or D) free discharge, (B or E) medium pressure, (C or F) maximum pressure. HS, high speed. LS, low speed.

- Performance tested in accordance with ISO 13347-3 2004.

* Radiated sound pressure level at 3m, at free field condition, with rigid ducts at the inlet and outlet.

The company is always improving and developing its products, therefore the company reserves the right of making changes to the illustrated products. Certified dimension can be provided upon request.