



APL Series

PROPELLER FANS



Propeller Fans – APL Series

- Propeller fan for wall or panel mounting suitable for supply or exhaust use.
- Sickle Blade impellers, installed with the external rotor motors.
- Wall plate is made of high grade steel sheet with painted finish, galvanized steel sheet wall plate can be supplied upon request.
- Fan impellers are statically and dynamically balanced to ISO 1940 standard.
- Low noise level with high efficiency.
- Accessories such as speed controller and mounting accessories can be supplied upon request.
- Model APL 710-1000 are not licensed by AMCA International.



Kruger Ventilation Industries Asia Co., Ltd certifies that the model APL 315-630 shown herein is licensed to bear the AMCA Seal. The ratings shown are based on tests and procedures performed in accordance with AMCA Publication 211 and AMCA Publication 311 and comply with the requirements of the AMCA Certified Ratings Program. Model APL 710-1000 are not licensed by AMCA International.

Dimension

315 - 710

1 PHASE 3 PHASE

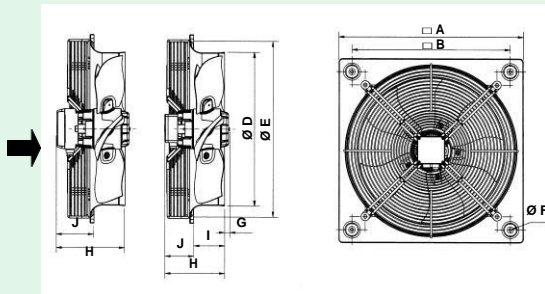

Model	□A	□B	ØD	ØE	ØF	G	H	I	J	Wt (kg)
APL 315 4P-1 1S	400	330	315	329	10	-	149	68	82	7.0
APL 355 4P-1 1S	450	380	355	371	10	-	156	75	82	7.5
APL 400 4P-1 1S	500	420	400	422	10	12	200	78	122	9.0
APL 450 4P-1 1S	560	480	450	476	10	-	204	91	114	11.5
APL 500 4P-1 1S	630	560	500	536	10	13	201	97	104	16.0
APL 500 6P-1 1S	630	560	500	536	10	-	201	97	104	16.0
APL 560 4P-1 1S	710	630	560	596	10	20	213	99	114	21.5
APL 560 6P-1 1S	710	630	560	596	10	2	213	99	114	21.5
APL 560 6P-3 1S	710	630	560	596	10	-	188	99	89	21.5
APL 630 4P-3 1S	800	710	630	674	12	25	182	103	79	24.0
APL 630 6P-3 1S	800	710	630	674	12	7	182	103	79	24.0
APL 710 6P-3 1S	900	800	710	733	12	11	206	92	115	27.0

Technical Data - 50Hz

Model	Max Q (m³/h)	Maximum Motor Input Power (W)	Motor Protection	Motor	N° Pole	Hz	Maximum Current (A)		Insulation Class	Lp (A) at 3m free discharge (dB (A))*	Speed (RPM)
							220V	400V			
APL 315 4P-1 1S	1886	112	IP54	Single Phase	4	50	0.60	-	F	46	1420
APL 355 4P-1 1S	2632	145	IP54	Single Phase	4	50	0.70	-	F	48	1345
APL 400 4P-1 1S	4792	268	IP54	Single Phase	4	50	1.20	-	F	52	1355
APL 450 4P-1 1S	6574	457	IP54	Single Phase	4	50	2.00	-	F	55	1325
APL 500 4P-1 1S	8183	867	IP54	Single Phase	4	50	3.60	-	F	56	1390
APL 500 6P-1 1S	5335	228	IP54	Single Phase	6	50	1.10	-	F	44	875
APL 560 4P-1 1S	10577	1084	IP54	Single Phase	4	50	4.60	-	F	57	1370
APL 560 6P-1 1S	6959	371	IP54	Single Phase	6	50	1.71	-	F	48	910
APL 560 6P-3 1S	7718	405	IP54	Three Phase	6	50	-	0.90	F	50	940
APL 630 4P-3 1S	12640	1066	IP54	Three Phase	4	50	-	2.20	F	61	1380
APL 630 6P-3 1S	10317	607	IP54	Three Phase	6	50	-	1.10	F	54	900
APL 710 6P-3 1S	15055	1019	IP54	Three Phase	6	50	-	2.20	F	57	910

* Inlet Lp(A) sound pressure levels at 3m are measured at free discharge in spherical free field condition, inlet Lp(A) (dB(A)) levels are not licensed by AMCA International.

- Performance ratings do not include the effects of appurtenances (accessories).

- Performance certified is for installation type A - Free inlet, Free outlet.

- Speed (RPM) shown is nominal. Performance is based on actual speed of test.

- Model APL 710 is not licensed by AMCA International.

Dimension

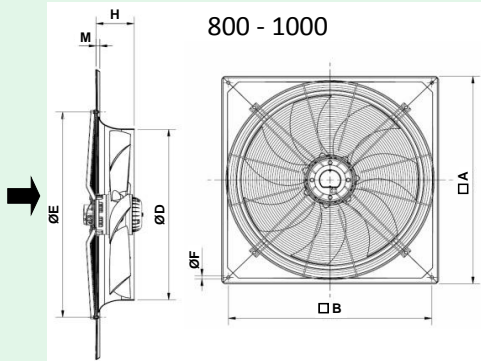

800 - 1000

Model	□A	□B	ØD	ØE	ØF	H	M	Wt (kg)
APL 800 6P-3 1S	970	910	797	914	14.5	170	17	46.0
APL 800 8P-3 1S	970	910	797	914	14.5	170	17	45.0
APL 900 12P-3 1S	1070	1010	914	1115	14.5	210	22	55.0
APL 1000 12P-3 1S	1170	1110	1000	1140	14.5	210	22	61.0

Technical Data - 50Hz

Model	Max Q (m³/h)	Maximum Motor Input Power (W)	Motor Protection	Motor	N° Pole	Hz	Maximum Current (A)		Insulation Class	Lp (A) at 3m free discharge (dB (A))*	Speed (RPM)
							220V	400V			
APL 800 6P-3 1S	21687	1909	IP54	Three Phase	6	50	-	3.80	F	63	900
APL 800 8P-3 1S	15567	802	IP54	Three Phase	8	50	-	1.50	F	52	630
APL 900 12P-3 1S**	18459	690	IP54	Three Phase	12	50	-	2.20	F	49	440
APL 1000 12P-3 1S**	23794	890	IP54	Three Phase	12	50	-	1.90	F	50	420

- Model APL 800 - 1000 are not licensed by AMCA International.

* Inlet Lp(A) sound pressure levels at 3m are measured at free discharge in spherical free field condition, inlet Lp(A)(dB(A)) levels are not licensed by AMCA International.

** Please consult KRUGER for fan selection of this model.

Performance Data - 50 Hz

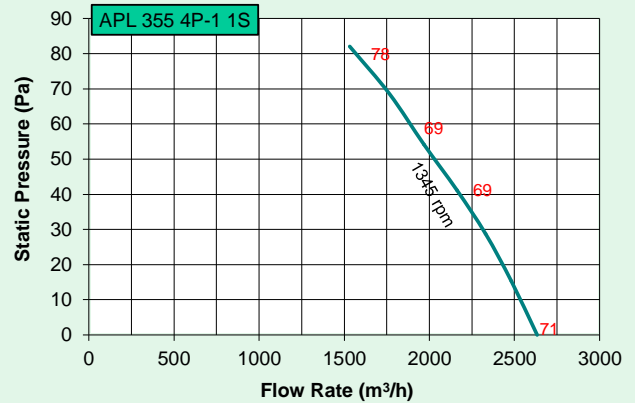
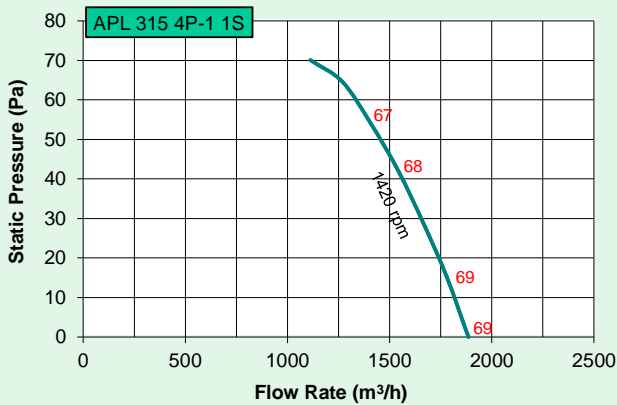

- Values shown are for inlet Lwi(A) sound power levels for installation type A: free inlet, free outlet. The A-weighted sound ratings shown have been calculated per AMCA International Standard 301.

- Performance certified is for installation type A – Free inlet, Free outlet.

- Performance ratings do not include the effects of appurtenances (accessories).

- Speed (RPM) shown is nominal. Performance is based on actual speed of test.

Performance Data - 50Hz

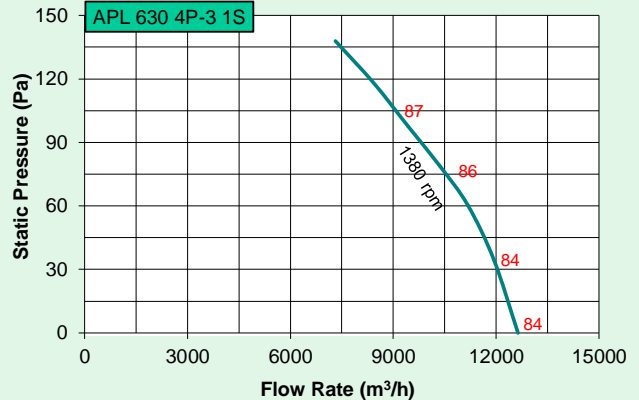
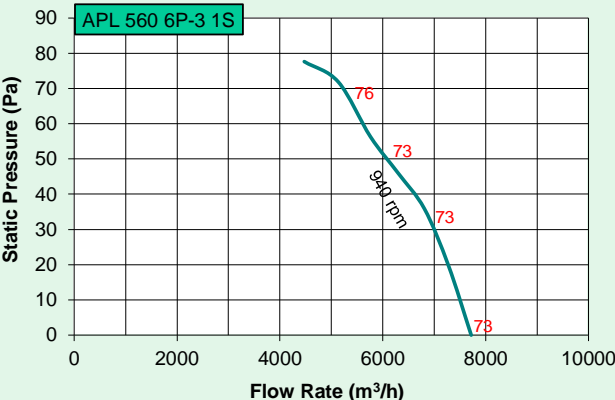
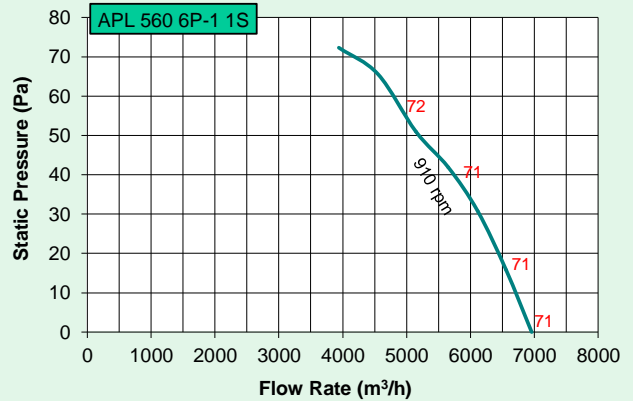
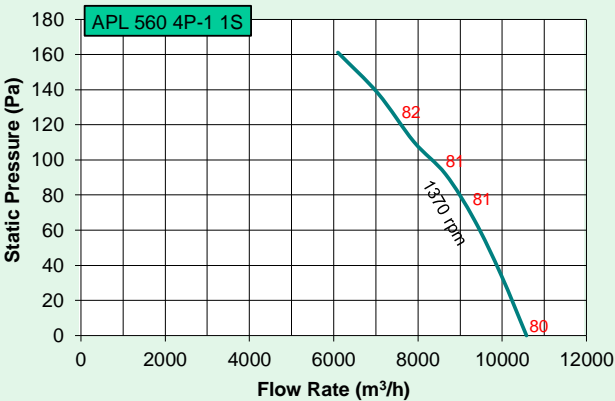
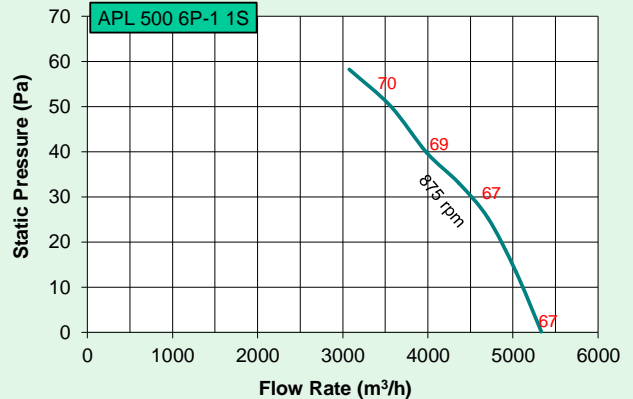
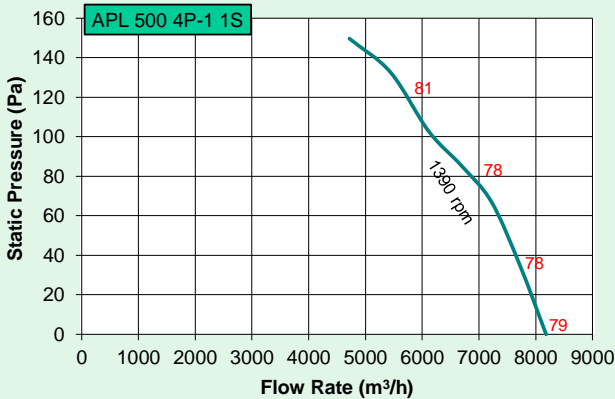
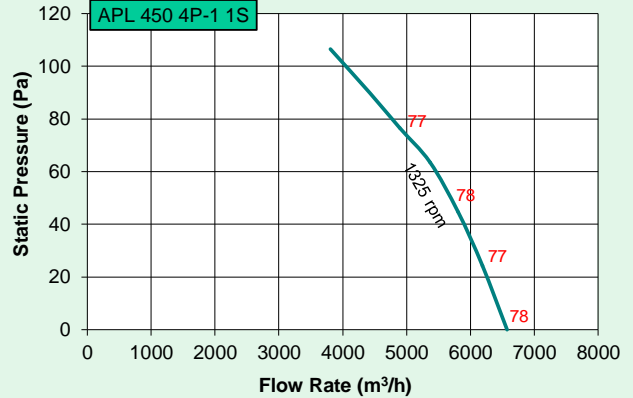
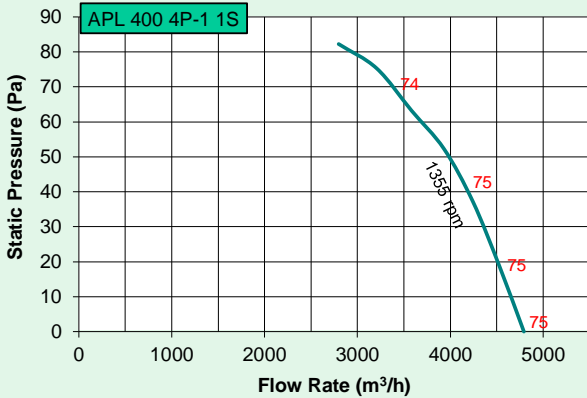

- Values shown are for inlet Lwi(A) sound power levels for installation type A: free inlet, free outlet. The A-weighted sound ratings shown have been calculated per AMCA International Standard 301.
- Performance certified is for installation type A – Free inlet, Free outlet.
- Performance ratings do not include the effects of appurtenances (accessories).
- Speed (RPM) shown is nominal. Performance is based on actual speed of test.

Performance Data - 50Hz

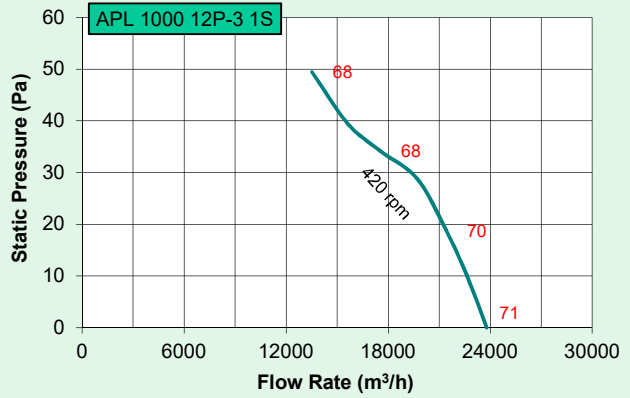
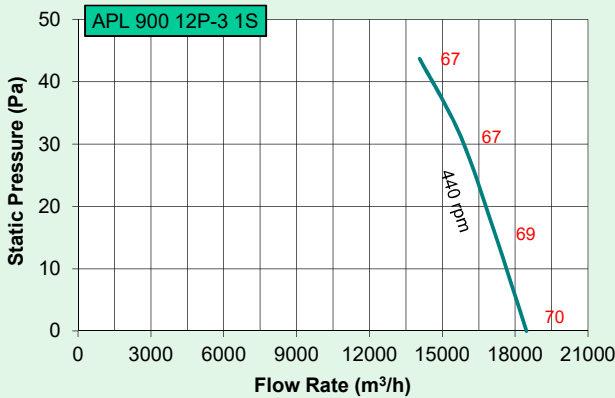
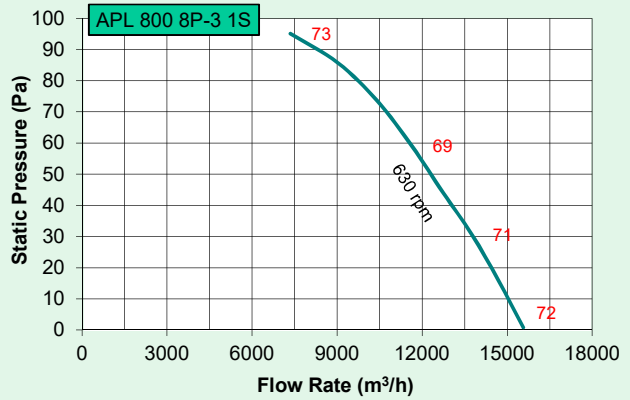
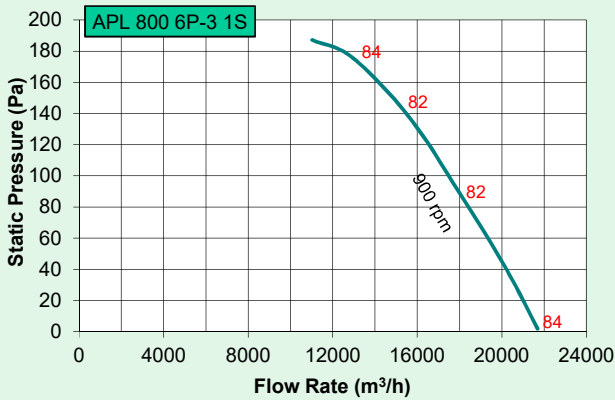
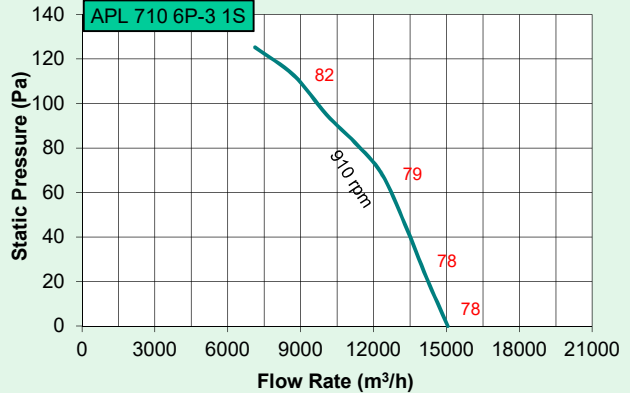
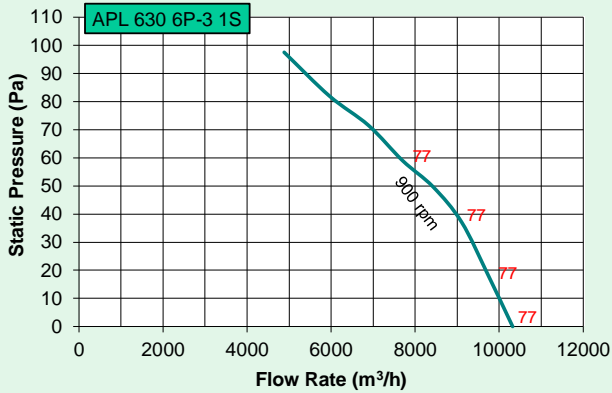

- Values shown are for inlet Lwi(A) sound power levels for installation type A: free inlet, free outlet. The A-weighted sound ratings shown have been calculated per AMCA International Standard 301.
- Performance certified is for installation type A – Free inlet, Free outlet.
- Performance ratings do not include the effects of appurtenances (accessories).
- Speed (RPM) shown is nominal. Performance is based on actual speed of test.
- Model APL 710 – 1000 are not licensed by AMCA International.

• THAILAND (Regional HQ)

KRUGER VENTILATION INDUSTRIES ASIA CO. LTD.

30/159 Moo 1, Sinsakorn Industrial Estate,
Chetsadawithi Road, Khok Kham Mueng, Samuthsakorn 74000, Thailand
Tel. +662 1054298 - Fax +662 0248256-9
Website: www.krugerfan.com

• CHINA (BEIJING)

BEIJING KRUGER VENTILATION CO. LTD

Level 7, A Block, Rising International Building, 29 JingHai San Road, BDA,
Beijing, P.R.China 100176
Tel. +86 10-67881366 - Fax +86 10-67880566
Email: krugertj@krugertj.com

• CHINA (SHANGHAI)

SHANGHAI KRUGER VENTILATION CO. LTD

No. 500 Yuanguo Road, Anting, Jiading,
Shanghai 201814 P.R. China
Tel. +86 21-69573266 - Fax +86 21-69573296
Email: shkruger@krugerchina.com

• CHINA (WUHAN)

WUHAN KRUGER VENTILATION CO. LTD

No. 805, Huian Ave, Dongxihu District, Wuhan, Hubei, P.R. China 430000
Tel. +86 27- 83248840/83060522/83097505
Fax +86 27- 83261886
Email: whkruger@krugerwh.com

• HONG KONG

KRUGER VENTILATION (HONG KONG) LIMITED

Fiat C, 9/F, Yeung Yiu Chung (No.8) Industrial Building,
20 Wang Hoi Road, Kowloon Bay, Kowloon, Hong Kong
Tel. +852 22469182 - Fax +852 22469187
Email: info@kruger.com.hk

• INDIA (NORTH)

KRUGER VENTILATION INDUSTRIES (NORTH INDIA) PVT LTD

Plot No. - 191, Sector - 59, Ballabgarh, Faridabad - 121 004, Haryana, India
Tel. +91-9958991660/9717449696
Fax. +91-1294135820
Email: sales.kni@krugerindia.com

• KOREA

NEOMATE CO. LTD

2-1010, Ace High Tech City B/D, 775 Gyeongin-ro,
Yeongdeungpo-gu, Seoul, Korea. Postal Code 07299
Tel. +82-2-2679-2052 - Fax. +82-2-2679-2174
Email: y7890@neomate.co.kr

• MYANMAR

KRUGER VENTILATION (MYANMAR) CO.LTD

Room No. F21, Thiri Yadanar Whole Sale Market, (Htawunbe)
Toe Chae Ward, North Okkalapa Township, Yangon.
Tel. +959 763141081/2/3
Email: htoon@krugermm.com

• SINGAPORE

KRUGER ENGINEERING PTE LTD

No. 10 Buroh Street #06-06, West Connect Building,
Singapore 627564
Tel. +65 68631191 - Fax +65 68631151
Email: mktg@krugerasia.com

• THAILAND

KRUGER VENTILATION IND. (THAILAND) CO. LTD

30/105 Moo 1, Sinsakorn Industrial Estate,
Chetsadawithi Road, Khok Kham Mueng, Samuthsakorn 74000, Thailand
Tel. +662 1050399 - Fax + 662 1050370-2
Email: mktg@kruger.co.th

• AUSTRALIA

S&P-KRUGER AUSTRALIA PTY LTD

2 Cunningham St, Moorebank N.S.W. 2170
Tel. +61 2-98227747
Fax. +61 2-98227757
Email: info@sandpkruiger.com.au

• CHINA (GUANGZHOU)

GUANGZHOU KRUGER VENTILATION CO. LTD

No. 9 Huahui Road, Huashan, Huadu,
Guangzhou, P.R. China 510880
Tel. +86 20-66356635 - Fax +86 20-86786001/86786500
Email: gzkruger@krugergz.com

• CHINA (TIANJIN)

TIANJIN KRUGER VENTILATION CO. LTD

No.168 Anyuan Road, Jingjin Science and Technology Park
Wuqing District, Tianjin, China
Tel. +86 22-22143480/3481 - Fax +86 22-22143482
Email: krugertj@krugertj.com

• DUBAI

KRUGER VENTILATION INDUSTRIES, GULF BRANCH

Jebel Ali Free Zone Area (JAFZA) P.O. Box No. 262949, Dubai, UAE
Tel. +971 4 8819188/8832017
Fax. +971 4 8832018
Email: johncs@krugerasia.com

• INDIA

KRUGER VENTILATION INDUSTRIES (INDIA) PVT LTD

Kruger Centre, Mumbai-Nasik Highway,
Kalamgaon, Shahapur, Thane 421601, Maharashtra, India
Tel. +91 9960558899/9975577211 - Fax +91 2527 240075
Email: sales@krugerindia.com

• INDONESIA

P.T. KRUGER VENTILATION INDONESIA

JL. Teuku Umar No.20,
Karawaci - Tangerang 15115, Indonesia
Tel. +62 21-5512288/5513557 - Fax +62 21-5513502
Email: mktg@krugerindo.co.id

• MALAYSIA

KRUVENT INDUSTRIES (M) SDN BHD

Lot 850, Jalan Subang 7, Taman Perindustrian Subang,
47500, Subang Jaya, Selangor D.E.
Tel. +603 80743399 - Fax +603 80743388
Email: mktg@kruger.com.my

• PHILIPPINES

KRUGER M&E INDUSTRIES CORPORATION

FAPI Compound, E. Rodriguez Ave.
Tunasan, Muntinlupa City 1773, Philippines
Tel. +63 2-8622892/4/6/7, 5534059 - Fax +63 2-8622891
Email: mktg@krugerp.net

• TAIPEI

KRUGER VENTILATION (TAIWAN) CO. LTD

No. 157, Ping-an Rd, Hengfeng Village,
Dayuan Shiang Taoyuan County 337, Taiwan
Tel. +886 3-3859119 - Fax +886 3-3859118
Email: sales@krugertwn.com.tw

• VIETNAM

KRUGER VENTILATION INDUSTRIES (VIETNAM) CO. LTD

Lot A7. 2-4, C2 Road, Thanh Thanh Cong IZ,
Trang Bang Dist. Tay Ninh Province, Vietnam
Tel. +84-276 3585200/01/02 - Fax +84-276 3585199
Email: mktg@krugervn.com

The company is always improving and developing its products, therefore the company reserves the right of making changes to the illustrated products. Certified dimension can be provided upon request.