

AXIAL FLOW FAN - belt driven



TBE

Construction

Belt driven type. Double flanged casing is produced in mild steel or galvanised steel. The impeller with manually adjustable pitch blades is made of PPG, PAG or Aluminium.

Finish

Painting or galvanised finish after manufacture is standard on all parts.

Operating Temperature

-20°C to +85°C

Motors

Total Enclosed Fan Cooled (TEFC), Class "F", IP54 protection. Standard motors up to 2.2kW are supplied with DOL starting. Motors 3.0kW and above are with star/delta starting. Motors of other specification are available upon request.

Airflow Direction

Air flowing from impeller to motor is fitted as standard. Air flow from motor to impeller can be supplied upon request.

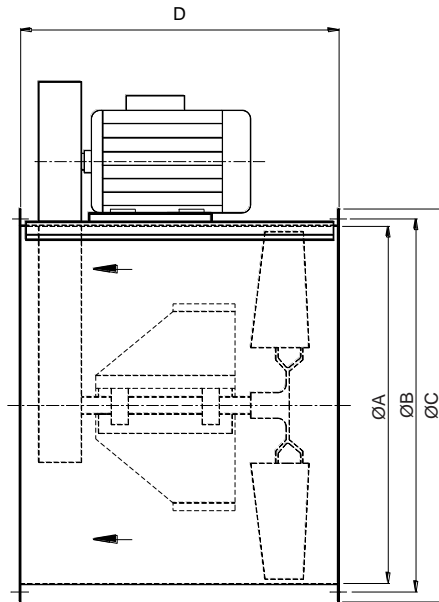
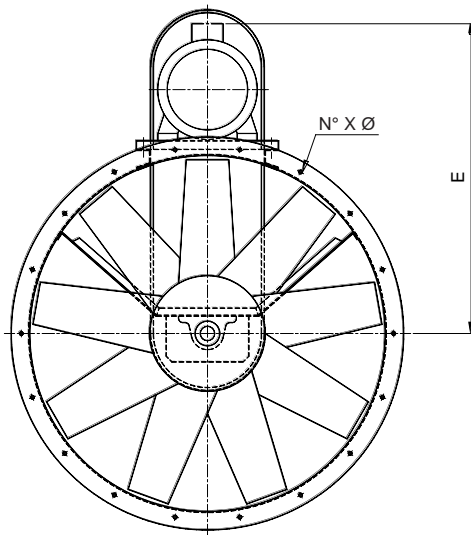

All Dimension in mm.

MODEL	A	B	C	D	E		N°	Ø	Weight (kg)	Max.Motor* FrameSize
					Min	Max				
315	315	355	395	475	380	440	8	10	15	D90L
355	355	395	435	475	400	460	8	10	17	D90L
400	400	440	480	475	445	485	12	10	19	D90L
450	450	490	530	475	470	540	12	10	21	D90L
500	500	540	580	560	500	590	12	10	31	D112M
560	560	605	660	560	570	650	12	10	36	D112M
630	630	675	730	710	610	680	12	10	44	D132M
710	710	755	810	710	650	725	18	12	64	D132M
800	800	845	900	710	700	775	18	12	72	D132M

MODEL	A	B	C	D	E		N°	Ø	Weight (kg)	Max.Motor* FrameSize
					Min	Max				
900	900	945	1000	750	750	825	18	12	83	D132M
1000	1000	1050	1100	750	810	885	24	12	93	D132M
1120	1120	1185	1250	1000	845	985	24	12	170	D180L
1250	1250	1315	1380	1120	930	1175	24	12	220	D200L
1400	1400	1465	1530	1120	1015	1335	32	14	330	D225M
1600	1600	1663	1730	1180	1155	1485	32	14	447	D250M
1800	1800	1856	1930	1250	1380	1640	32	14	630	D250M
2000	2000	2073	2130	1320	1475	1735	32	14	1150	D250M

* Please consult KRUGER if motor frame size is beyond the catalogue range --- Weight without motor and impeller.

The company is always improving and developing its products, therefore the company reserves the right of making changes to the illustrated products. Certified dimension can be provided upon request.

2 POLES - 2800 RPM

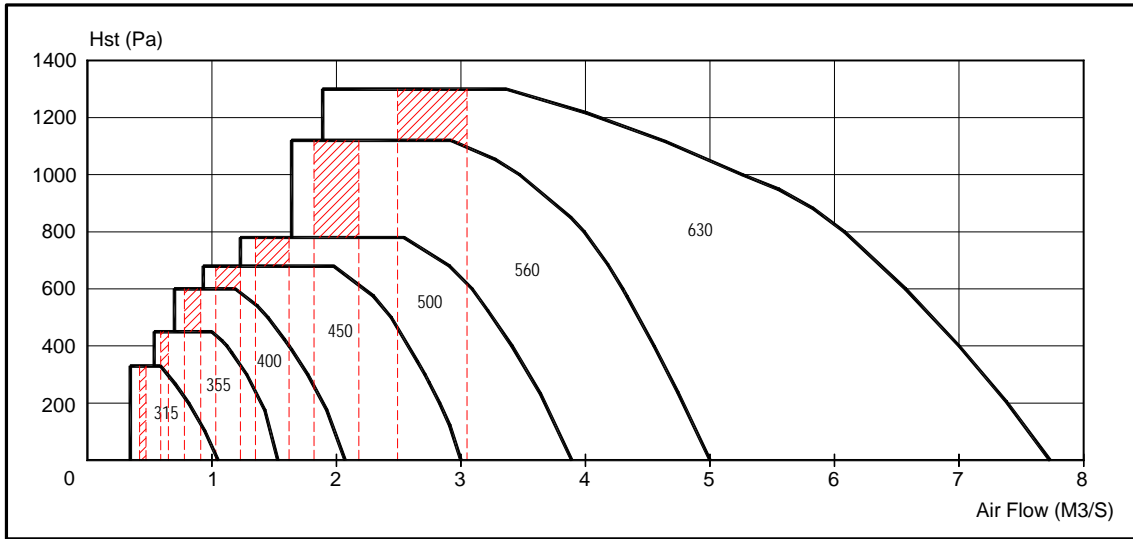

4 POLES - 1420 RPM

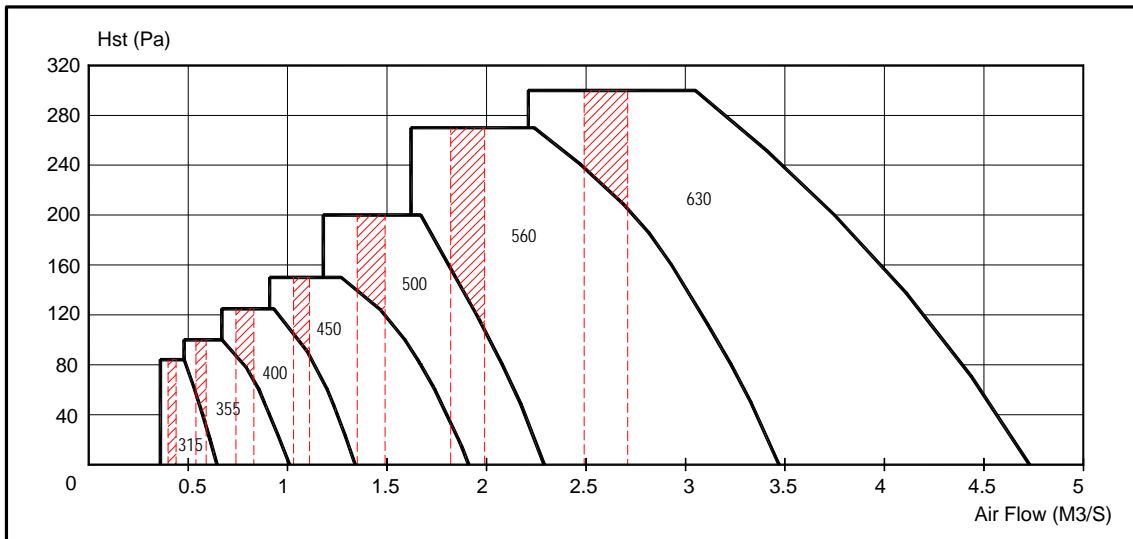

4 POLES - 1420 RPM

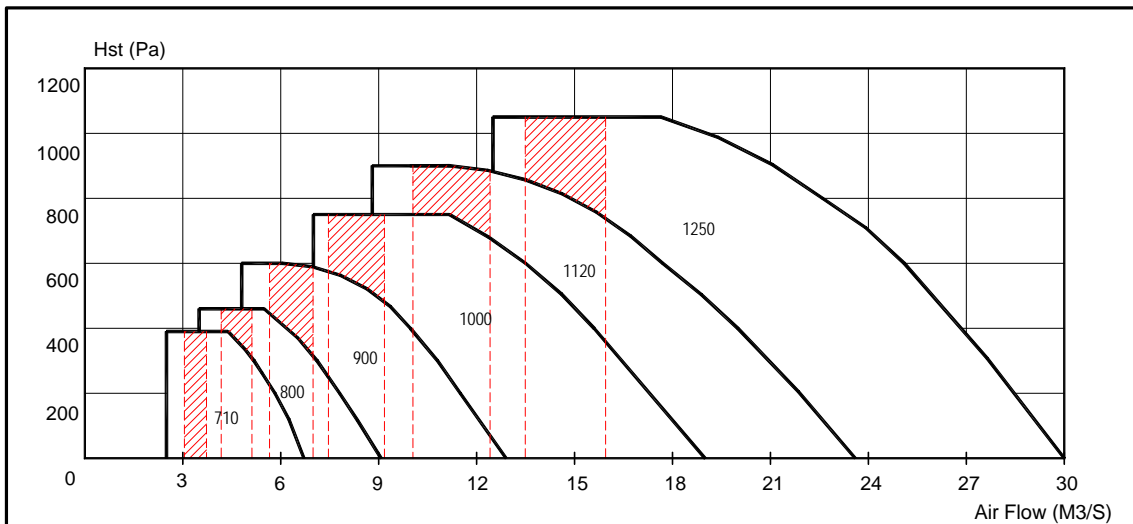

*** Shaded portion is the recommended operating range based on the duct velocity consideration (friction loss of 1 Pa/m)

6 POLES - 900 RPM

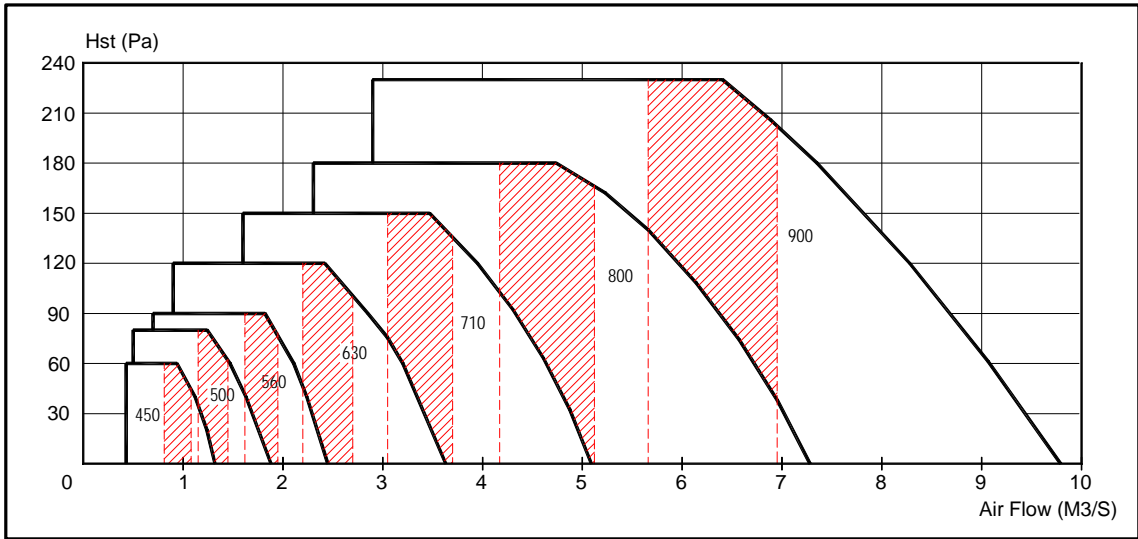

6 POLES - 900 RPM

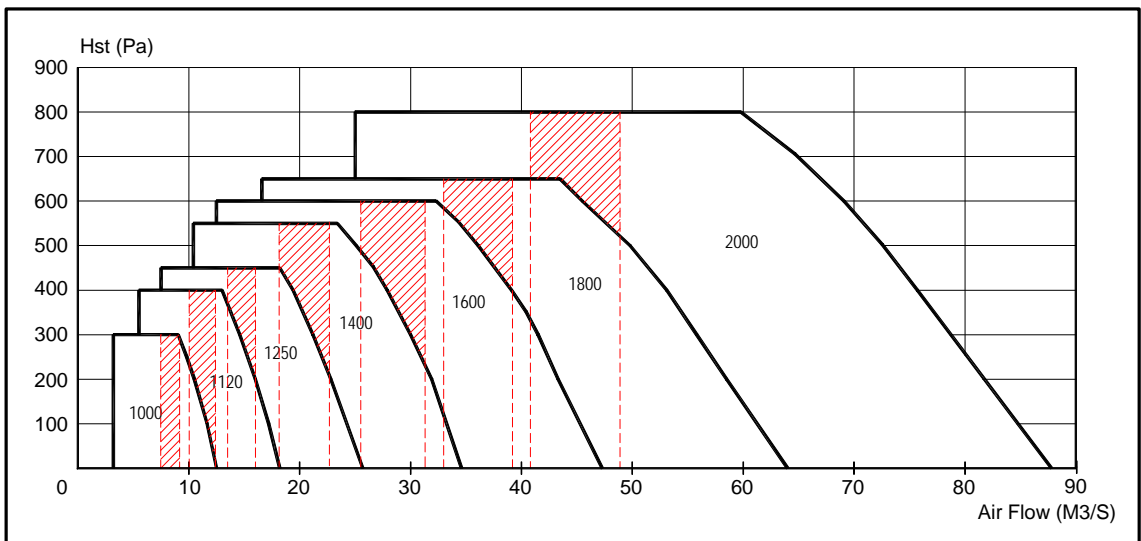

8 POLES - 720 RPM

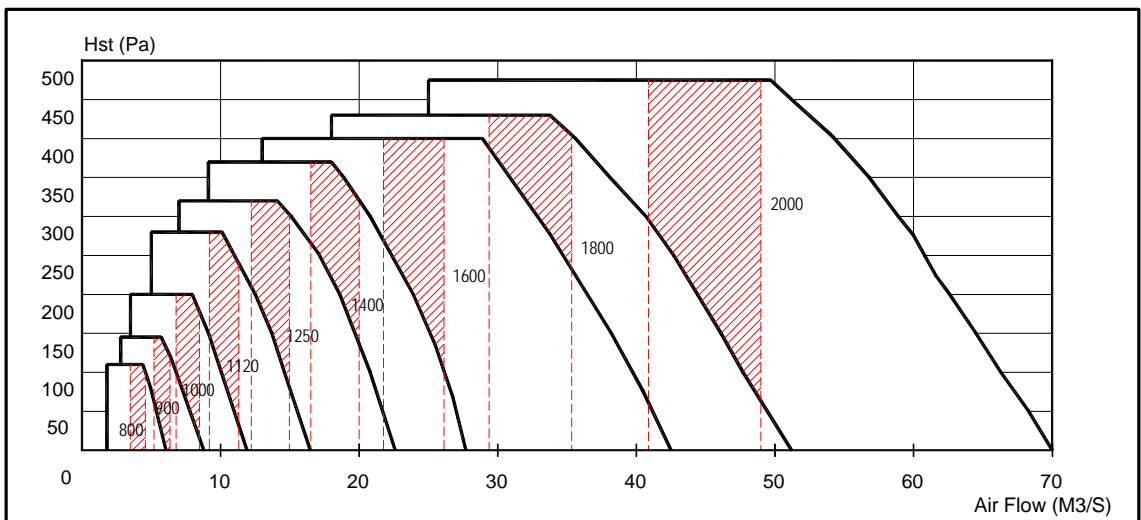

*** Shaded portion is the recommended operating range based on the duct velocity consideration (friction loss of 1 Pa/m)

4 POLES - 1750 RPM

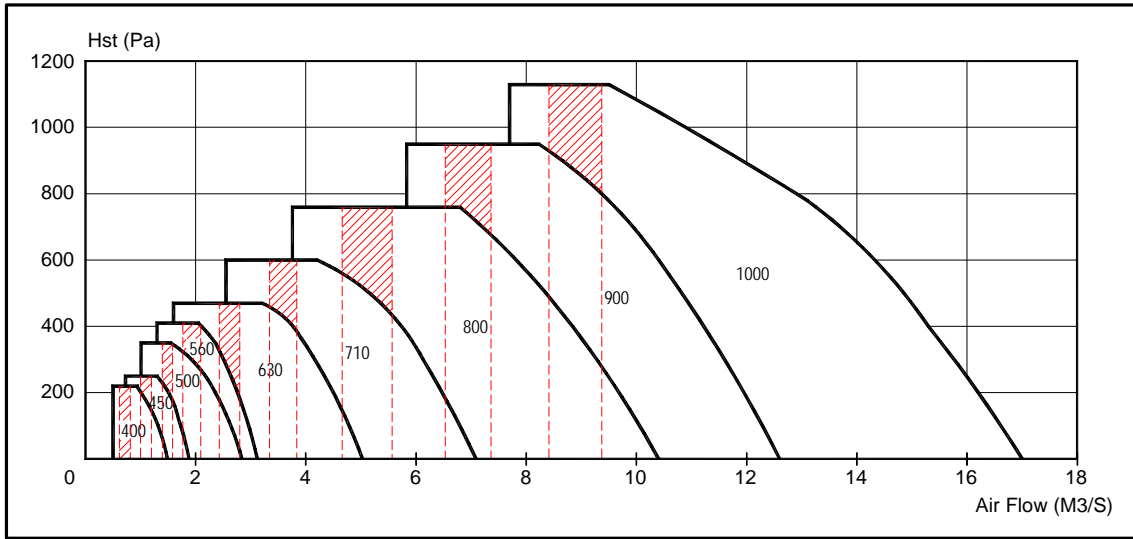

6 POLES - 1150 RPM

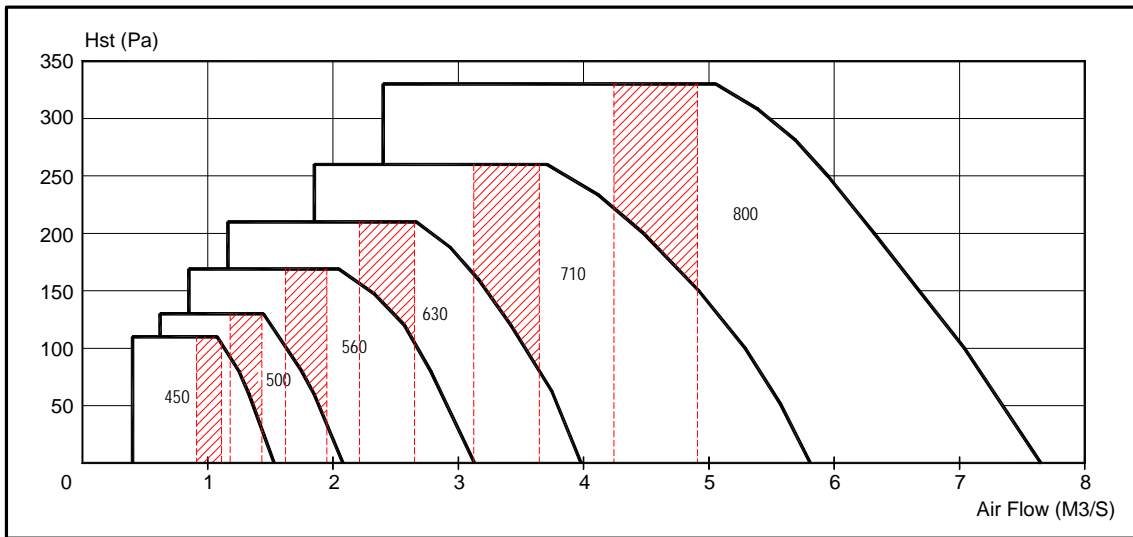

6 POLES - 1150 RPM

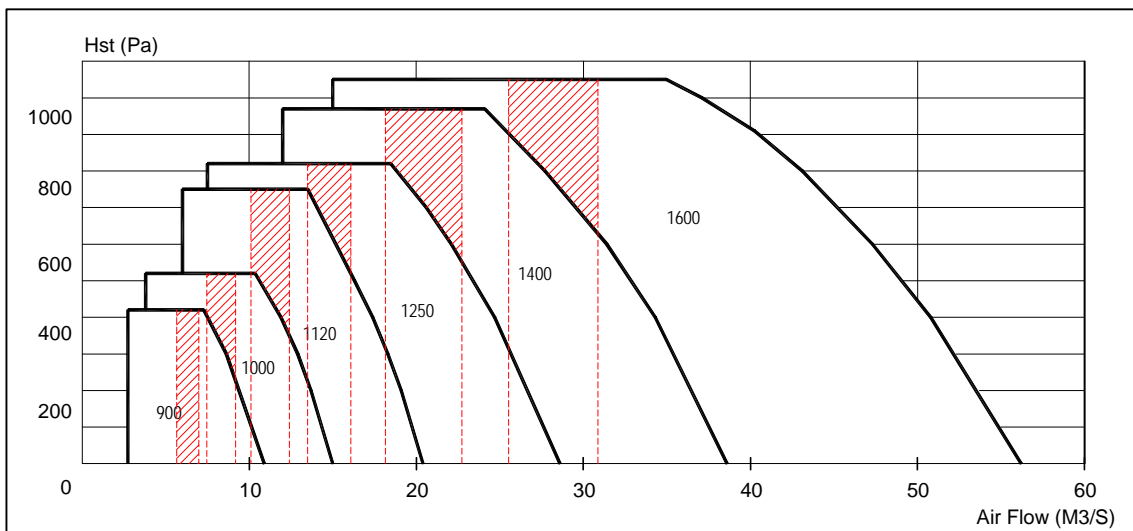

*** Shaded portion is the recommended operating range based on the duct velocity consideration (friction loss of 1 Pa/m)