

ECOWATT eBNC X Series Plenum fan

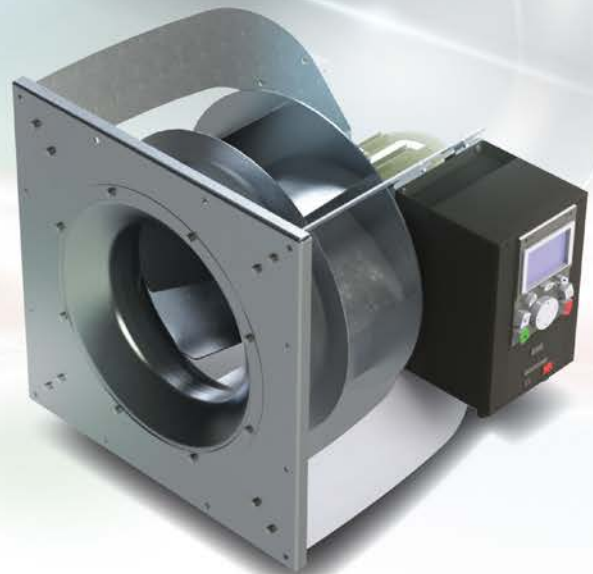

Energy (W) Efficient

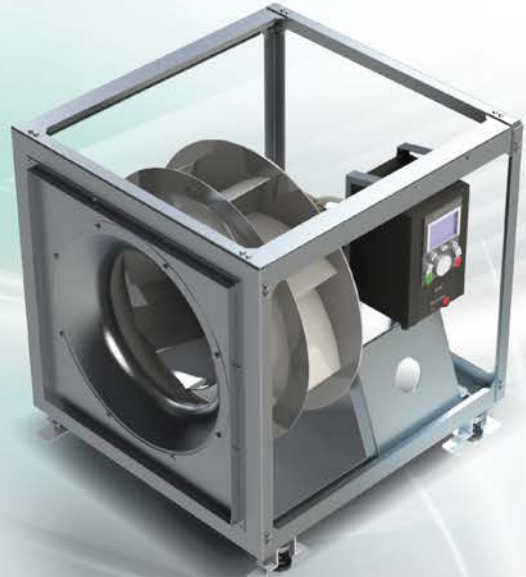

Powerful



Economical

What is Ecowatt eBNC X Series EC Plenum Fan

- ✓ The Ecowatt eBNC 315-630 X series is a newly developed, direct drive, compact and highly efficient backward curved EC plenum fan solution for air handling units.
- ✓ The engineered combination of impeller, EC motor and drive delivers unparalleled energy efficiency & power.
- ✓ The aluminium BNC-Q impeller is a 3rd generation performance optimized CFD design with FEA to enhance structural safety.
- ✓ Energy saving PID function VFD with an efficient IE4 EC Motor.

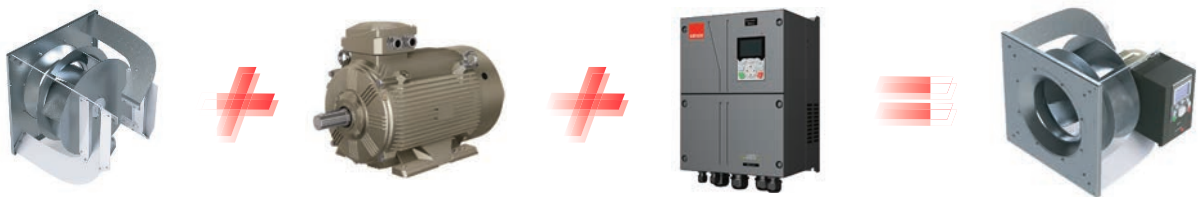

Other Specifications

- Aerodynamic & Boomerang Spider Bracket Design for Models eBNC 315-560 X
- Cube Frame for Models eBNC 630 X for Increased Stability
- Standard Energy Saving with PID Function to Optimize Power Consumption
- Compact & Versatile
- Speed Control Via 3 Simple Methods

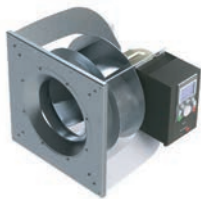

eBNC 315-560 X



eBNC 630 X



Speed Regulation

- Manual speed control 0-10V via Potentiometer.
- Automatic control signal 0-10Vdc or 4-20mA from Demand Controlled Ventilation (DCV) or Building Management System (BMS).
- Automatic control by Modbus RTU program connected via RS 485 interface.



REB-ECOWATT
Manual control



Constant Airflow
Constant Pressure
Auto control TDP-PI



Modbus
Interface

Why Use a Kruger Ecowatt eBNC X Plenum Fan

- ✓ More Power to Deliver High Static and Airflow with less Fan Quantities.
- ✓ Highly Efficient PM Synchronous Motor with Energy Saving PID function VFD.
- ✓ Drive and Motor are Manufacturer Interdependence, reducing the Potential for Expensive Replacements.
- ✓ Less Fan Quantities reduce the Effect of Constrained Fan in a Cabinet.
- ✓ It is AMCA Certified to Airflow, Sound and FEI.

Single Fan Vs Multiple Fans

When the distance between multiple fans in an array is compact, the blockage effect from the fans nearby will constrain the flow development and lead to a very high rotational flow resulting in significant flow/pressure loss. This effect is similar to the fans inside a confined cabinet. See Figure 1

This effect does not happen on single fan within a cabinet. The Ecowatt eBNC has higher single fan airflow threshold that allows single fan to operate over a larger operating region of the AHU.

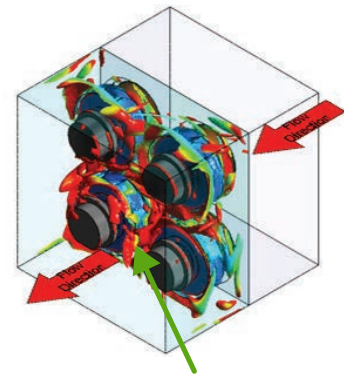

Figure 1: Area of air -turbulence

The Typical AHU AirflowCurve

The larger Ecowatt eBNC X has the capability to handle up to 6 cubic metre per second of airflow at 1000 Pa static pressure with a single fan. See Fig 2

This eliminates the blockage effect caused by having multiple fans constrained in a cabinet.

Where installation losses are applied in constrained fans to offset the loss of airflow and pressure, it caused the fans to operate at either a higher speed or require more fan quantities to deliver the same duty point which ultimately consumed additional input energy resulting in lower system efficiency.

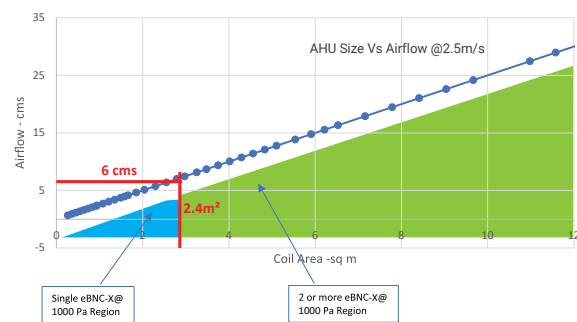

Figure 2 : Typical AHU Models Vs Airflow

The single fan Ecowatt eBNC X is well suited to delivering an engineered solution and keeping customer a peace of mind.

Certification

Kruger Ventilation Industries Asia Co., Ltd. Certifies that the Ecowatt eBNC X series shown herein is licensed to bear the AMCA seal. The ratings shown are based on tests and procedures performed in accordance with AMCA Publication 211 and AMCA Publication 311 and comply with the requirements of the AMCA Certified Ratings Program.



High Balancing Quality



Motor impeller is statically and dynamically balanced to ISO 14694:2003 and AMCA 204-G2.5 (Fig 3). Standard G1.0 standard is available upon request.

Figure 3

Recommended Applications

- ✓ Fan for New Air Handling Units.
- ✓ Refurbished Fan for Existing Air Handling Units.
- ✓ Clean Rooms, Data Centres, Commercial Buildings, Offices.
- ✓ Ideally Suited for Energy Saving Low Power Input System with Climate and Demand Control Ventilation Applications.
- ✓ Plug and play installation

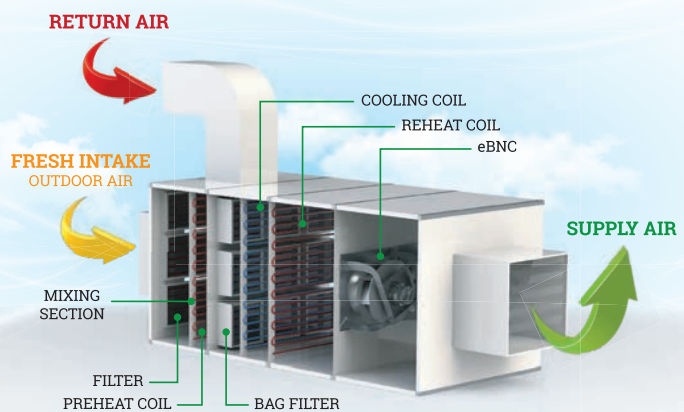

Performance Data Table Overview - Ecowatt eBNC X

Fan summary data at maximum fan speed. The installed PM motor model and power are thoughtfully analyzed and selected to ensure a high motor loading factor at the maximum impeller speed for cost optimization.

No	Model	Ps range	Ps	Airflow	Speed	Hs	FEI	LwA	Max Pwr Input	Max Amp	Freq	Input Vot	Operation Temp	Weight
			Pa	cms	rpm	%		dB	kW	I	Hz	V	°C	kg
1	eBNC 315 LP X-1.5 kW-3000	L	919	0.90	2820	55.8	1.43	86	1.49	3.00	50/60	400	-20 to 40	41
2	eBNC 315 MP X-2.2 kW-3000	M	1235	1.04	3270	59.7	1.43	93	2.20	4.49	50/60	400	-20 to 40	44
3	eBNC 315 HP X-3.0 kW-3000	H	1539	1.19	3720	56.6	1.30	96	3.22	5.90	50/60	400	-20 to 40	47
4	eBNC 355 LP X-2.2 kW-3000	L	942	1.30	2610	60.0	1.45	89	2.04	3.62	50/60	400	-20 to 40	47
5	eBNC 355 MP X-3.0 kW-3000	M	1257	1.54	3000	62.1	1.41	89	3.13	6.20	50/60	400	-20 to 40	49
6	eBNC 355 HP X-4.0 kW-3000	H	1556	1.48	3270	57.9	1.29	95	3.99	7.04	50/60	400	-20 to 40	56
7	eBNC 400 LP X-3.0 kW-3000	L	869	1.79	2250	61.8	1.45	86	2.52	5.13	50/60	400	-20 to 40	59
8	eBNC 400 MP X-4.0 kW-3000	M	1210	1.95	2610	61.8	1.38	95	3.82	6.62	50/60	400	-20 to 40	59
9	eBNC 400 HP X-5.5 kW-3000	H	1572	1.92	2879	60.4	1.31	96	5.75	9.72	50/60	400	-20 to 40	65
10	eBNC 450 LP X-2.2 kW-1500	L	740	2.02	1845	62.6	1.49	85	2.38	4.36	50/60	400	-20 to 40	65
11	eBNC 450 MP X-5.5 kW-3000	M	1179	2.43	2295	63.6	1.39	92	4.51	7.43	50/60	400	-20 to 40	67
12	eBNC 450 HP X-7.5 kW-3000	H	1572	2.94	2700	61.6	1.30	97	7.28	11.80	50/60	400	-20 to 40	72
13	eBNC 500 LP X-3.0 kW-1500	L	803	2.56	1712	64.2	1.47	87	3.20	6.11	50/60	400	-20 to 40	72
14	eBNC 500 MP X-4.0 kW-1500	M	997	2.79	1896	63.2	1.40	89	4.40	7.50	50/60	400	-20 to 40	80
15	eBNC 500 HP X-11.0 kW-3000	H	1597	3.77	2506	62.9	1.30	98	9.57	15.31	50/60	400	-20 to 40	88
16	eBNC 560 LP X-5.5 kW-1500	L	935	3.60	1665	64.2	1.40	89	5.24	9.20	50/60	400	-20 to 40	97
17	eBNC 560 MP X-7.5 kW-1500	M	1256	4.09	1921	64.4	1.35	93	7.99	12.79	50/60	400	-20 to 40	96
18	eBNC 560 HP X-15.0 kW-3000	H	1534	4.71	2203	61.9	1.27	101	11.69	18.04	50/60	400	-20 to 40	101
19	eBNC 630 LP X-5.5 kW-1500	L	860	4.41	1414	65.4	1.43	92	5.80	9.34	50/60	400	-20 to 40	132
20	eBNC 630 MP X-7.5 kW-1500	M	1097	4.85	1589	67.6	1.43	94	7.87	12.90	50/60	400	-20 to 40	134
21	eBNC 630 HP X-11.0 kW-1500	H	1437	5.41	1816	66.2	1.35	102	11.76	18.55	50/60	400	-20 to 40	150

Table 1

Exploded Diagram

To optimize is for EC motor operations, the wheel of the Ecowatt eBNC X is specially made from lightweight aluminium material and with its 7 backwards curved welded profile blade, it delivers high speed with strong airflow and static pressure with good efficiency and reliable operations.

Ecowatt eBNC 315-560 X

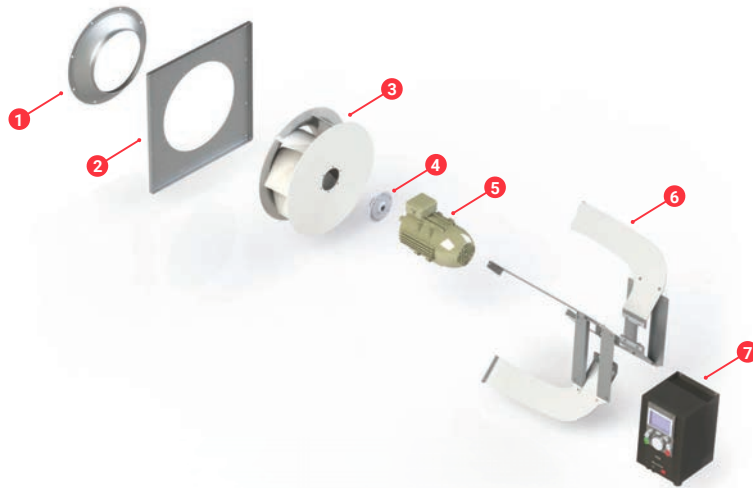

Ecowatt eBNC 630 X

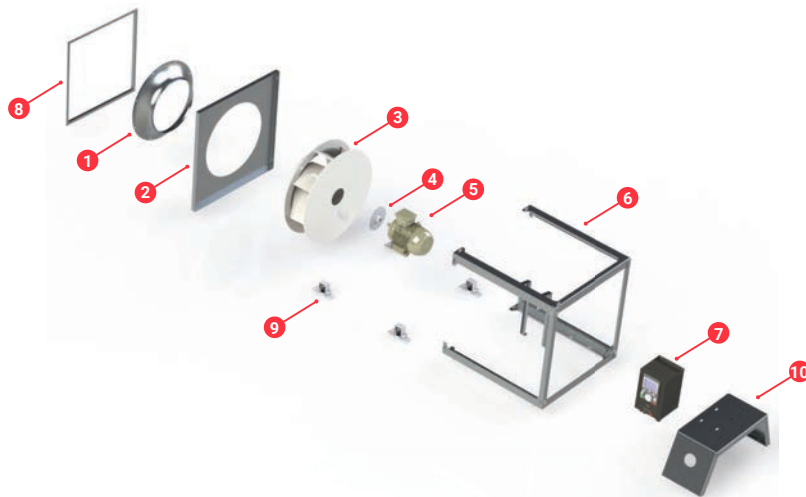

Fan Information

No.	Component	Material
1	Inlet cone	Galvanized steel
2	Inlet cone frame	Galvanized steel
3	Wheel	Aluminium
4	Hub	Aluminium
5	Motor	Aluminium Enclosure
6	Fan frame	Galvanized steel
7	VFD	Painted steel
8	Inlet flange	Galvanized steel
9	Spring isolator	Painted steel
10	Motor support	Galvanized steel

Model Number NOMENCLATURE

1 2 3 4 5 6 7 8 9 10 11 12 13 14 15 16
 E X X X X X X X X - X X - X X

Digit 1 - Product Category

"E" = Plenum Fan

Digit 2, 3 - Fan Series

"NC" = BNC

Digit 4 - Fan Dive Type

"D" = Motor Direct Drive

Digit 5, 6 - Pressure range

"P1" = Type P (L)

"P2" = Type P (M)

"P3" = Type P (H)

"R1" = Type R (L)

"R2" = Type R (M)

"R3" = Type R (H)

"Q1" = Type Q (L)

"Q2" = Type Q (M)

"Q3" = Type Q (H)

Digit 7,8,9 - Fan Model

"031" = 315 "080" = 800

"035" = 355 "090" = 900

"040" = 400 "100" = 1000

"045" = 450 "112" = 1120

"050" = 500 "125" = 1250

"056" = 560 "140" = 1400

"063" = 630 "160" = 1600

"071" = 710 "180" = 1800

Digit 10 - Motor Frame Size

"A" = Motor SanmuMtr3.25kw400/3/50-60(EC112D-L1HL03) S2

"B" = Motor SanmuMtr1.85kw400/3/50-60(EC112D-L1HL01) S5

"C" = Motor WulongMtr3.0kw380/3/50-60(EM13210A412A4) W3

"D" = Motor WulongMtr3.0kw380/3/50-60(EM13210A412B2) W5

"E" = Mtr V IE4 noB3FC 1.5kW/4P 55F 380-3-100&VFD K 3PH IP54 5.5KW VT 380V 50/60HZ

"F" = Mtr V IE4 noB3FC 2.2kW/4P 55F 380-3-100&VFD K 3PH IP54 5.5KW VT 380V 50/60HZ

"G" = Mtr V IE4 noB3FC 3kW/4P 55F 380-3-100&VFD K 3PH IP54 5.5KW VT 380V 50/60HZ

"H" = Mtr K IE4 noB3FC 4kW/4P 55F 380-3-100&VFD K 3PH IP54 5.5KW VT 380V 50/60HZ

"J" = Mtr V IE4 noB3FC 5.5kW/4P 55F 380-3-100&VFD K 3PH IP54 5.5KW VT 380V 50/60HZ

"K" = Mtr V IE4 noB3FC 2.2kW/4P 55F 380-3-50&VFD K 3PH IP54 5.5KW VT 380V 50/60HZ

"L" = Mtr V IE4 noB3FC 7.5kW/4P 55F 380-3-100&VFD K 3PH IP54 7.5KW VT 380V 50/60HZ

"M" = Mtr V IE4 noB3FC 3kW/4P 55F 380-3-50&VFD K 3PH IP54 5.5KW VT 380V 50/60HZ

"N" = Mtr V IE4 noB3FC 4kW/4P 55F 380-3-50&VFD K 3PH IP54 5.5KW VT 380V 50/60HZ"

"P" = Mtr V IE4 noB3FC 11kW/4P 55F 380-3-100&VFD K 3PH IP54 11KW VT 380V 50/60HZ

"Q" = Mtr V IE4 noB3FC 5.5kW/4P 55F 380-3-50&VFD K 3PH IP54 5.5KW VT 380V 50/60HZ

"R" = Mtr V IE4 noB3FC 7.5kW/4P 55F 380-3-50&VFD K 3PH IP54 7.5KW VT 380V 50/60HZ

"S" = Mtr V IE4 noB3FC 15kW/4P 55F 380-3-100&VFD K 3PH IP54 15KW VT 380V 50/60HZ

"T" = Mtr V IE4 B3FC 5.5kW/4P 55F 380-3-50&VFD K 3PH IP54 5.5KW VT 380V 50/60HZ

"V" = Mtr V IE4 B3FC 11kW/4P 55F 380-3-50&VFD K 3PH IP54 11KW VT 380V 50/60HZ

"U" = Mtr V IE4 B3FC 7.5kW/4P 55F 380-3-50&VFD K 3PH IP54 7.5KW VT 380V 50/60HZ

"W" = Mtr V IE4 B3FC 15kW/4P 55F 380-3-50&VFD K 3PH IP54 15KW VT 380V 50/60HZ

"X" = Mtr V IE4 B3FC 18.5kW/4P 55F 380-3-50&VFD K 3PH IP54 18KW VT 380V 50/60HZ

Digit 11, - None

Digit 14, - None

Digit 12, 13 - Revision

"00" = None

Digit 15, 16 - Configuration/Others

"00" = None

Example

ENCDP1031B-00-00 - Plenum Fan eBNC 315 LP (S5)

ENCDP3031A-00-00 - Plenum Fan eBNC 315 HP (S2)

ENCDP1050C-00-00 - Plenum Fan eBNC 500 LP (W3)

ENCDQ3056S-00-00 - Plenum Fan eBNC 560 HP X MTR15kW VFD15kW

Drawings & Dimensions (eBNC 315-630 X)

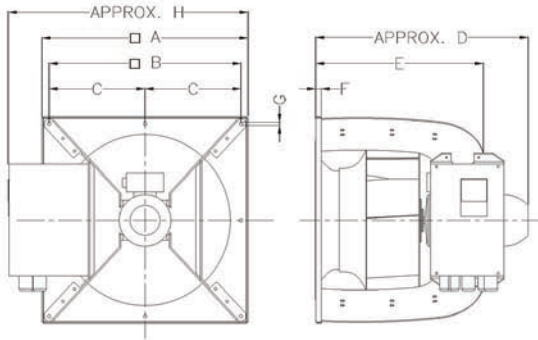

Ecovatt eBNC 315-400 X

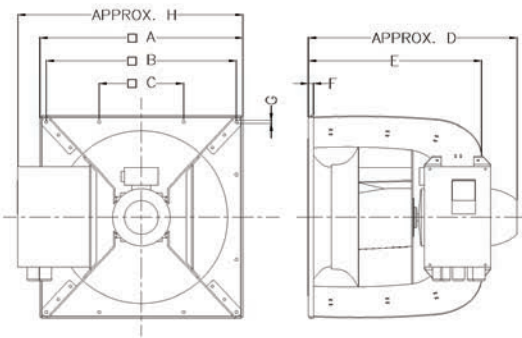

Ecovatt eBNC 450-560 X

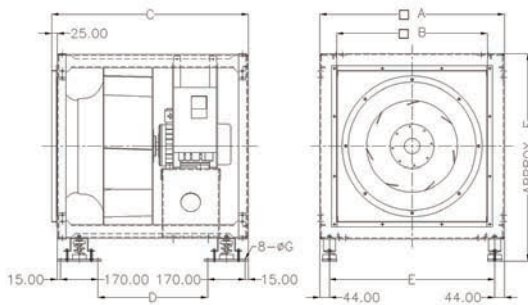

Ecovatt eBNC 630 X

Model	A	B	C	D	E	F	G	H
315 LP	450	411	205.5	441	350	15	9	590
315 MP	450	411	205.5	478	370	15	9	590
315 HP	450	411	205.5	513	380	15	9	590
355 LP	500	461	230.5	505	400	15	9	614
355 MP	500	461	230.5	540	414	15	9	614
355 HP	500	461	230.5	540	414	15	9	614
400 LP	550	512	256	567	454	15	9	640
400 MP	550	512	256	567	454	15	9	640
400 HP	550	512	256	587	475	15	9	640
450 LP	600	562	250	617	512	15	9	665
450 MP	600	562	250	617	512	15	9	665
450 HP	600	562	250	656	532	15	9	665
500 LP	670	622	250	659	555	25	11	700
500 MP	670	622	250	698	570	25	11	700
500 HP	670	622	250	698	570	25	11	747
560 LP	730	662	250	754	636	25	11	730
560 MP	730	662	250	775	643	25	11	730
560 HP	730	662	250	775	643	25	11	778

Dimension Table for Ecovatt eBNC 315-560 X

Model	A	B	C	D	E	F	G
630 LP	840	687	895	500	752	941	10
630 MP	840	687	895	500	752	941	10
630 HP	840	687	895	500	752	941	10

Dimension Table for Ecovatt eBNC 630 X

Consolidated Ecowatt eBNC 315-630 X Fan Performance Curves Overview

The graph below shows an overview of the maximum air performance for all the models measured in a chamber test rig. Red lines are high pressure curves, blue for medium pressure models and green for low pressure models.

Performance certified is for Installation Type A-Free Inlet & Free Outlet with Partition.

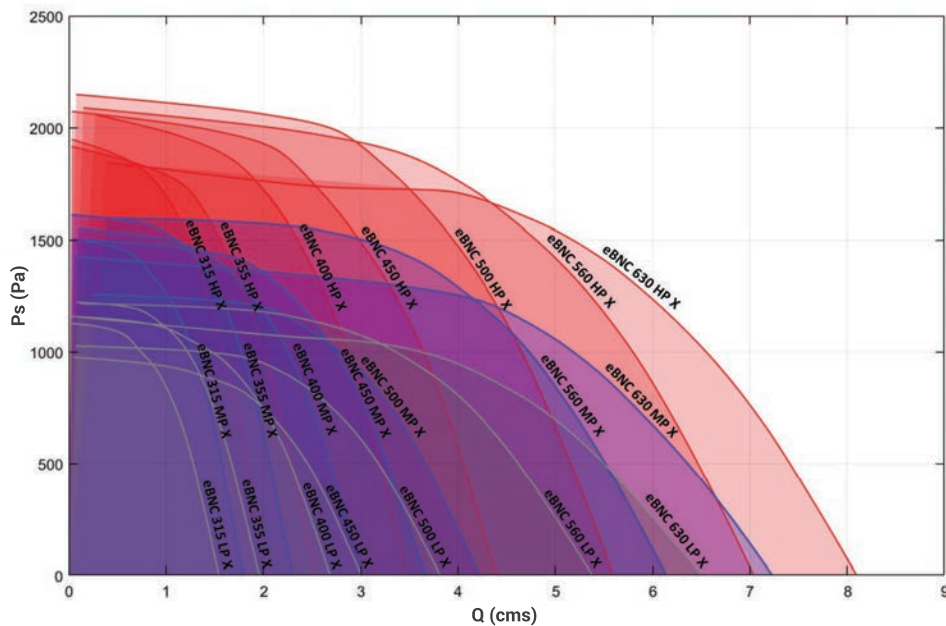

The graph shows the maximum air performance for each size. Choosing the most optimum size to fit your performance requirement will result in the most optimum cost. The right fan for every application.

Models Ecowatt eBNC 315 to 560 X are designed with galvanized steel spider bracket for fan wall mounting. The spider includes the motor impeller, a base for the VFD, an inlet cone and a square mounting plate for mounting to fan wall.

Model Ecowatt eBNC 630 X is with cube design made from galvanized steel material for floor mounting. The cube includes a base supporting the motor, a bracket for the VFD, an inlet cone and 4 pieces of spring isolators.

Installation & Connection

- Models eBNC 315-560 X are designed with spider bracket for fan wall installation.
- Models eBNC 630 X are designed with cube frame for direct mounting to floor of AHU.
- For recommended installation space, refer to section on "Installation Space"

Fan Wall Installation

- Ensure the wall is rigidly constructed, strong and capable to withstand and support the weight of multiple or single fan during operation.
- Mount the Ecowatt eBNC X fan to the fan wall through the 4 holes provided on the mounting panel.
- To prevent air leakage, it is advisable to seal off the fan from the pressure wall.

Floor Standing Installation with Attachment to Fan Wall

- Cube design floor mounting is applicable to heavier and larger models like 630.
- Connection to fan wall on the air intake side through flexible duct.
- Floor mount provides better stability with the increase in mass of the larger models.
- To prevent air leakage, it is advisable to seal off the fan from the pressure wall.



Wall Mounting for Spider Design



Floor mounting for Cube Design

Installation Space

When selecting the EC plenum fan, it is recommended to allow a minimum distance of 1 fan diameter between the wall of the AHU casing and the centre of the fan and for multiple fans, a minimum of 2 fan diameters between the centre of the 2 impellers. Upstream and downstream components shall be at least 1 fan diameter away from either the inlet or peripheral of the fan (outlet side). Sound and air performance may be affected if distances are lower than the minimum required.

For distances below the minimum required, the effect of the confined cabinet and installation space on the fan performance can be calculated as below.

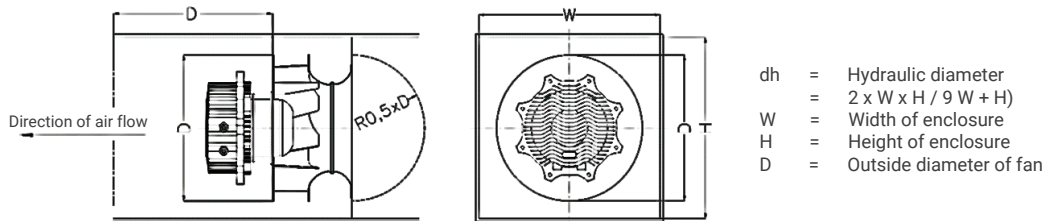

Given the dimensions of the enclosure, the corresponding hydraulic diameter can be calculated and used to determine the corresponding airflow correction factor. Noticed that at correction factor of 100% or 1 which is equivalent to 1.9 hydraulic diameter, no deduction in airflow is required.

Refer to Fig 4 below for appropriate correction factor when dh/D is lower than 1.9.

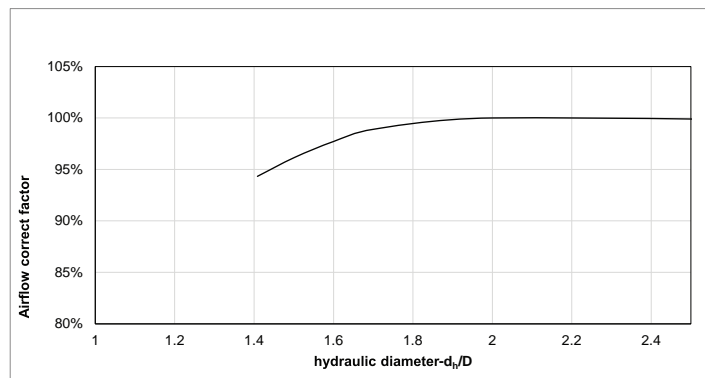

Figure 4: Correction factor values for airflow fan size eBNC 315-630 X

Note: The airflow correction factor due to the effect of the confined cabinet and installation space are not AMCA Certified.

Characteristics Fan Curves

Fan curves at the maximum speed and 3 partial speeds with FEI curves and corresponding curves for power input and fan system static efficiency and data table for all 24 models.

Ecowatt eBNC 315 LP X – 1.5 kW – 3000

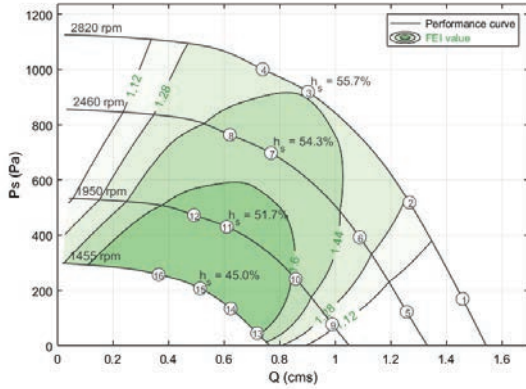

Point	Voltage (V)	Freq (Hz)	Nominal Speed (rpm)	Ps (Pa)	Q (cms)	W (kW)	Hs (%)	I (A)	LwA
1	400	50	2820	170	1.458	1.19	20.9	2.28	95
2	400	50	2820	519	1.267	1.41	46.6	2.95	91
3	400	50	2820	919	0.902	1.49	55.7	3.00	90
4	400	50	2820	1001	0.739	1.39	53.3	2.86	91
5	400	50	2460	123	1.257	0.80	19.3	1.54	91
6	400	50	2460	393	1.088	0.94	45.4	1.85	88
7	400	50	2460	698	0.769	0.99	54.3	1.93	85
8	400	50	2460	764	0.621	0.92	51.4	1.79	86
9	400	50	1950	78	0.989	0.42	18.4	0.96	87
10	400	50	1950	242	0.858	0.49	42.8	1.12	85
11	400	50	1950	431	0.610	0.51	51.7	1.13	81
12	400	50	1950	473	0.492	0.48	48.8	1.19	82
13	400	50	1455	46	0.719	0.20	16.3	0.46	82
14	400	50	1455	135	0.624	0.23	37.2	0.53	78
15	400	50	1455	208	0.514	0.24	45.0	0.61	74
16	400	50	1455	258	0.365	0.22	42.1	0.55	74

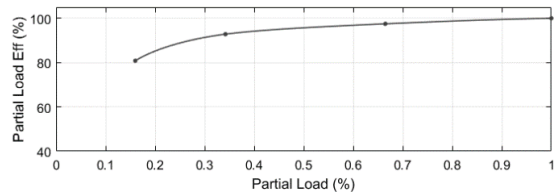
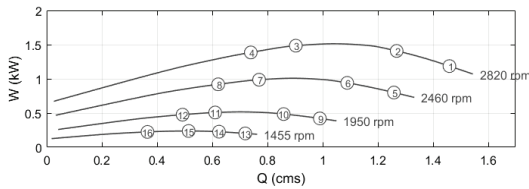

Ecowatt eBNC 315 MP X – 2.2 kW – 3000

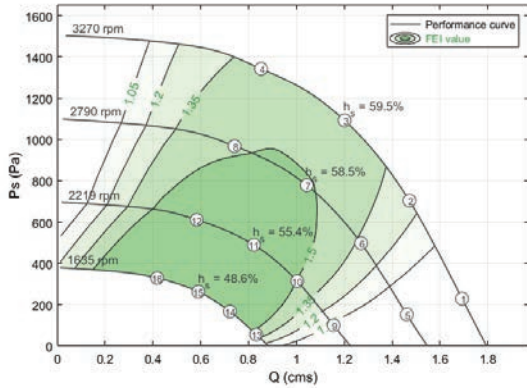

Point	Voltage (V)	Freq (Hz)	Nominal Speed (rpm)	Ps (Pa)	Q (cms)	W (kW)	Hs (%)	I (A)	LwA
1	400	50	3270	229	1.692	1.77	21.9	3.76	100
2	400	50	3270	704	1.472	2.07	49.9	4.31	95
3	400	50	3270	1093	1.201	2.20	59.5	4.49	93
4	400	50	3270	1343	0.852	2.02	56.4	4.16	96
5	400	50	2790	152	1.461	1.12	19.8	2.49	96
6	400	50	2790	498	1.270	1.30	48.5	2.84	92
7	400	50	2790	779	1.043	1.39	58.5	2.77	90
8	400	50	2790	968	0.741	1.28	55.9	2.61	90
9	400	50	2219	100	1.155	0.60	19.3	1.31	90
10	400	50	2219	314	1.003	0.68	46.0	1.60	86
11	400	50	2219	490	0.822	0.73	55.4	1.62	84
12	400	50	2219	611	0.583	0.67	52.8	1.49	85
13	400	50	1635	55	0.832	0.27	16.9	0.59	87
14	400	50	1635	167	0.722	0.30	40.0	0.66	83
15	400	50	1635	263	0.590	0.32	48.6	0.72	82
16	400	50	1635	329	0.418	0.30	46.1	0.70	82

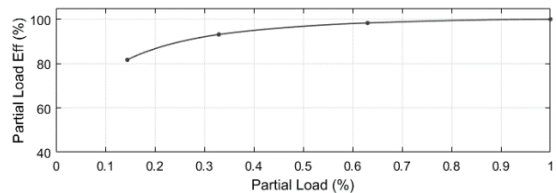
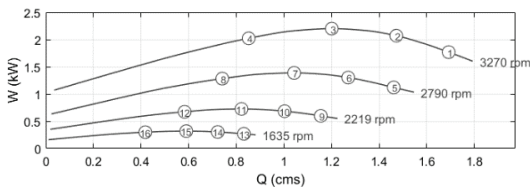

Speed (RPM) shown is nominal. Performance is based on actual speed of test. Ps is static pressure, Q is airflow, W is motor control power input measured, Hs is fan static efficiency, I is input current, LwA is A-weighted outlet sound power. Performance certified is for installation type A-Free Inlet, Free Outlet with partition. Performance ratings do not include the effects of appurtenances (accessories). FEIs values are calculated in accordance with ANSI/AMCA Standard 208 and are based on wire-to-air measurement, (AMCA 211 ratings). The A-weighted sound ratings shown have been calculated per AMCA International Standard 301. Values shown are for outlet LwA sound power levels for installation type A-Free Inlet, Free Outlet with partition. EC motor model number KPMA-63M-1.5-3000 for eBNC 315 LP X. EC motor model number KPMA-71M-2.2-3000 for eBNC 315 MP X.

Ecowatt eBNC 315 HP X – 3.0 kW – 3000

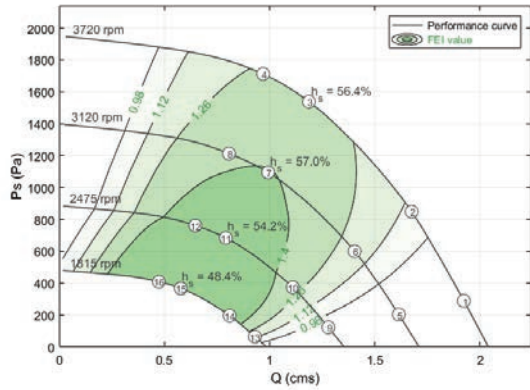

Point	Voltage (V)	Freq (Hz)	Nominal Speed (rpm)	Ps (Pa)	Q (cms)	W (kW)	Hs (%)	I (A)	LwA
1	400	50	3720	289	1.923	2.71	20.5	5.11	103
2	400	50	3720	849	1.675	3.11	45.7	6.13	99
3	400	50	3720	1539	1.187	3.22	56.4	5.90	97
4	400	50	3720	1713	0.969	3.05	54.2	5.65	97
5	400	50	3120	203	1.614	1.61	20.2	3.06	99
6	400	50	3120	600	1.404	1.83	46.1	3.43	94
7	400	50	3120	1095	0.993	1.90	57.0	3.65	93
8	400	50	3120	1213	0.807	1.80	54.3	3.42	94
9	400	50	2475	123	1.279	0.85	18.4	1.62	93
10	400	50	2475	374	1.110	0.96	43.2	1.88	89
11	400	50	2475	684	0.792	1.00	54.2	1.91	87
12	400	50	2475	762	0.647	0.95	51.8	1.77	88
13	400	50	1815	64	0.930	0.38	15.6	0.77	86
14	400	50	1815	196	0.810	0.42	37.6	0.85	84
15	400	50	1815	367	0.578	0.44	48.4	0.90	82
16	400	50	1815	409	0.474	0.42	46.1	0.93	82

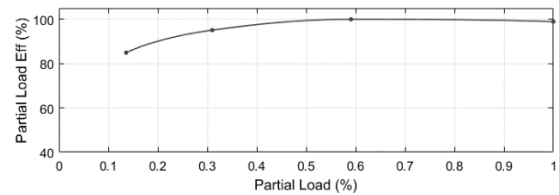
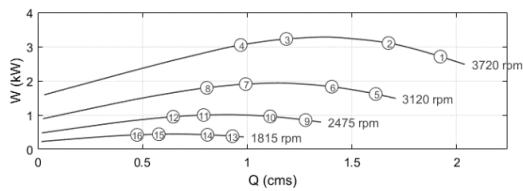

Ecowatt eBNC 355 LP X – 2.2 kW – 3000

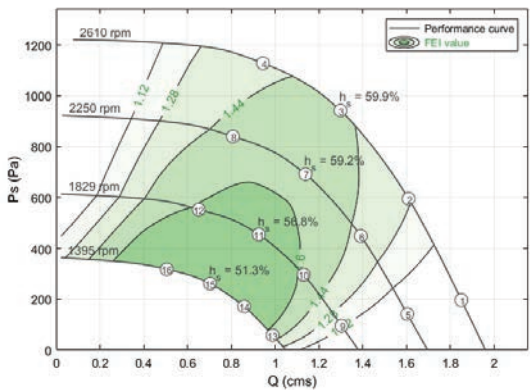

Point	Voltage (V)	Freq (Hz)	Nominal Speed (rpm)	Ps (Pa)	Q (cms)	W (kW)	Hs (%)	I (A)	LwA
1	400	50	2610	196	1.850	1.56	23.2	2.85	98
2	400	50	2610	595	1.609	1.89	50.7	3.46	94
3	400	50	2610	942	1.298	2.04	59.9	3.62	91
4	400	50	2609	1128	0.944	1.88	56.6	3.34	91
5	400	50	2250	141	1.603	1.02	22.3	2.09	93
6	400	50	2250	448	1.391	1.23	50.4	2.47	90
7	400	50	2250	692	1.138	1.33	59.2	2.62	87
8	400	50	2250	840	0.807	1.22	55.6	2.45	87
9	400	50	1829	95	1.303	0.58	21.6	1.06	88
10	400	50	1829	296	1.130	0.69	48.6	1.30	86
11	400	50	1829	454	0.925	0.74	56.8	1.36	84
12	400	50	1829	552	0.651	0.68	53.0	1.27	84
13	400	50	1395	58	0.988	0.29	19.8	0.56	85
14	400	50	1395	171	0.858	0.34	43.5	0.64	83
15	400	50	1395	261	0.703	0.36	51.3	0.69	82
16	400	50	1395	317	0.505	0.33	47.9	0.66	81

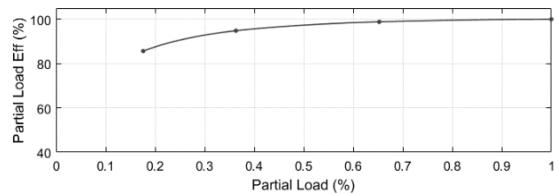
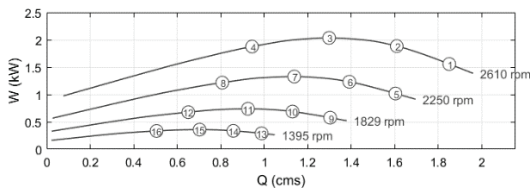

Speed (RPM) shown is nominal. Performance is based on actual speed of test. Ps is static pressure, Q is airflow, W is motor control power input measured, Hs is fan static efficiency, I is input current, LwA is A-weighted outlet sound power. Performance certified is for installation type A-Free Inlet, Free Outlet with partition. Performance ratings do not include the effects of appurtenances (accessories). FEI values are calculated in accordance with ANSI/AMCA Standard 208 and are based on wire-to-air measurement, (AMCA 211 ratings). The A-weighted sound ratings shown have been calculated per AMCA International Standard 301. Values shown are for outlet LwA sound power levels for installation type A-Free Inlet, Free Outlet with partition. EC motor model number KPMA-80M-3.0-3000 for eBNC 315 HP X. EC motor model number KPMA-71M-2.2-3000 for eBNC 355 LP X.

Ecowatt eBNC 355 MP X – 3.0 kW – 3000

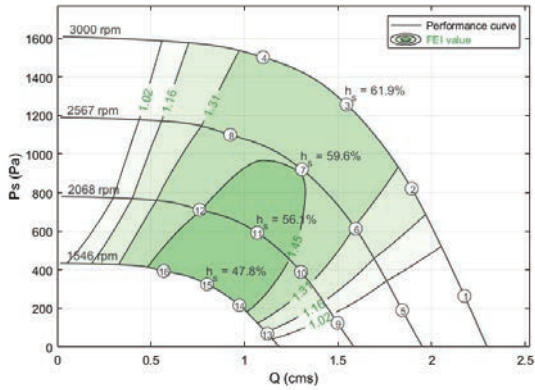

Point	Voltage (V)	Freq (Hz)	Nominal Speed (rpm)	Ps (Pa)	Q (cms)	W (kW)	Hs (%)	I (A)	LwA
1	400	50	3000	264	2.175	2.41	23.8	4.85	98
2	400	50	3000	821	1.893	2.93	53.0	5.96	93
3	400	50	3000	1257	1.545	3.13	61.9	6.20	89
4	400	50	3000	1502	1.099	2.84	57.9	5.27	93
5	400	50	2566	190	1.843	1.57	22.2	2.80	95
6	400	50	2567	613	1.594	1.90	51.4	3.38	90
7	400	50	2567	920	1.307	2.01	59.6	3.42	86
8	400	50	2567	1100	0.924	1.84	55.1	3.23	90
9	400	50	2068	124	1.497	0.90	20.7	1.65	89
10	400	50	2068	389	1.302	1.06	47.8	1.99	86
11	400	50	2068	592	1.068	1.12	56.1	2.13	83
12	400	50	2068	711	0.760	1.04	51.9	1.93	85
13	400	50	1546	69	1.122	0.45	17.1	0.87	84
14	400	50	1546	216	0.973	0.52	40.6	1.00	82
15	400	50	1546	325	0.800	0.54	47.8	1.19	80
16	400	50	1546	394	0.569	0.51	43.8	1.01	79

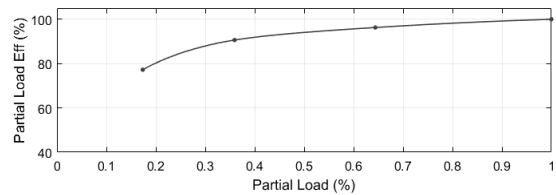
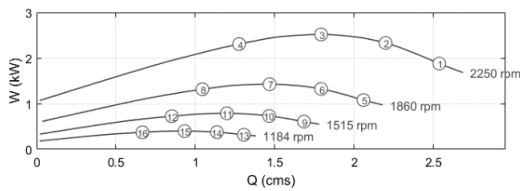

Ecowatt eBNC 355 HP X – 4.0 kW – 3000

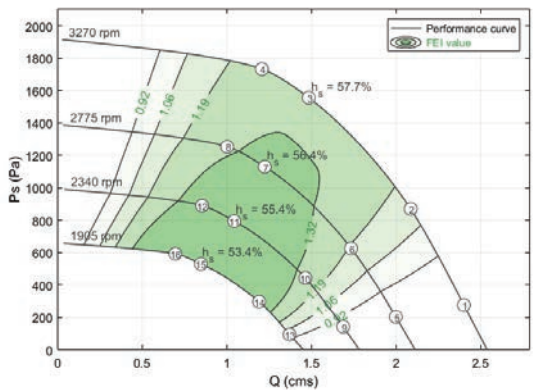

Point	Voltage (V)	Freq (Hz)	Nominal Speed (rpm)	Ps (Pa)	Q (cms)	W (kW)	Hs (%)	I (A)	LwA
1	400	50	3270	277	2.401	3.17	21.0	5.77	103
2	400	50	3270	870	2.087	3.75	48.4	6.76	100
3	400	50	3270	1556	1.485	3.99	57.7	7.04	96
4	400	50	3270	1733	1.208	3.79	54.9	6.71	97
5	400	50	2775	204	1.999	1.95	20.9	3.58	99
6	400	50	2775	627	1.735	2.30	47.3	4.22	96
7	400	50	2775	1130	1.225	2.45	56.4	4.44	92
8	400	50	2775	1254	1.003	2.33	53.9	4.25	93
9	400	50	2340	143	1.688	1.20	20.1	2.24	95
10	400	50	2340	444	1.465	1.41	46.2	2.61	93
11	400	50	2340	795	1.045	1.50	55.4	2.73	90
12	400	50	2340	890	0.855	1.43	53.0	2.64	90
13	400	50	1905	95	1.372	0.69	19.0	1.52	90
14	400	50	1905	298	1.192	0.79	44.7	1.74	88
15	400	50	1905	530	0.848	0.84	53.4	1.78	87
16	400	50	1905	593	0.697	0.81	51.2	1.76	87

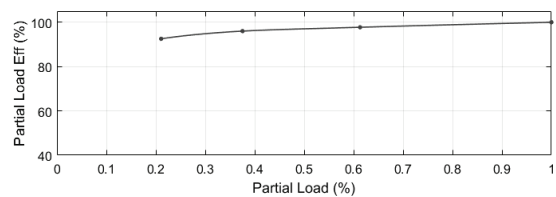
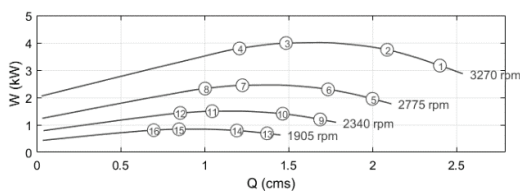

Speed (RPM) shown is nominal. Performance is based on actual speed of test. Ps is static pressure, Q is airflow, W is motor control power input measured, Hs is fan static efficiency, I is input current, LwA is A-weighted outlet sound power. Performance certified is for installation type A-Free Inlet, Free Outlet with partition. Performance ratings do not include the effects of appurtenances (accessories). FEl values are calculated in accordance with ANSI/AMCA Standard 208 and are based on wire-to-air measurement, (AMCA 211 ratings). The A-weighted sound ratings shown have been calculated per AMCA International Standard 301. Values shown are for outlet LwA sound power levels for installation type A-Free Inlet, Free Outlet with partition. EC motor model number KPMA-80M-3.0-3000 for eBNC 355 MP X EC motor model number KPMA-80M-4.0-3000 for eBNC 355 HP X

Ecowatt eBNC 400 LP X – 3.0 kW – 3000

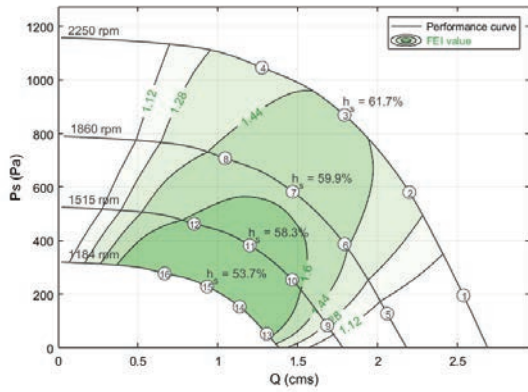

Point	Voltage (V)	Freq (Hz)	Nominal Speed (rpm)	Ps (Pa)	Q (cms)	W (kW)	Hs (%)	I (A)	LwA
1	400	50	2250	196	2.535	1.88	26.4	3.99	98
2	400	50	2250	581	2.197	2.33	54.7	4.74	93
3	400	50	2250	869	1.791	2.52	61.7	5.13	89
4	400	50	2250	1046	1.275	2.31	57.7	4.75	91
5	400	50	1860	128	2.058	1.08	24.4	2.40	92
6	400	50	1860	388	1.791	1.32	52.5	2.93	89
7	400	50	1860	583	1.467	1.43	59.9	3.17	86
8	400	50	1860	708	1.044	1.32	56.1	2.95	86
9	400	50	1515	84	1.683	0.61	23.3	1.32	88
10	400	50	1515	254	1.464	0.73	50.8	1.63	86
11	400	50	1515	383	1.198	0.79	58.3	1.74	84
12	400	50	1515	463	0.851	0.72	54.3	1.56	84
13	400	50	1184	52	1.305	0.32	21.5	0.65	85
14	400	50	1184	154	1.135	0.37	46.7	0.80	84
15	400	50	1184	229	0.932	0.40	53.7	0.85	83
16	400	50	1184	278	0.666	0.37	49.9	0.75	85

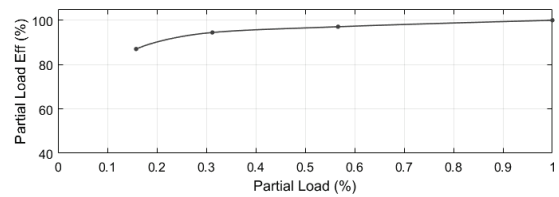
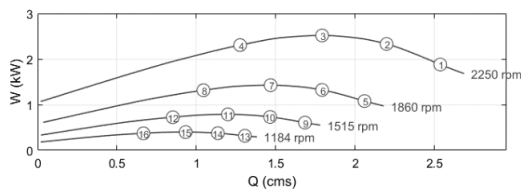

Ecowatt eBNC 400 MP X – 4.0 kW – 3000

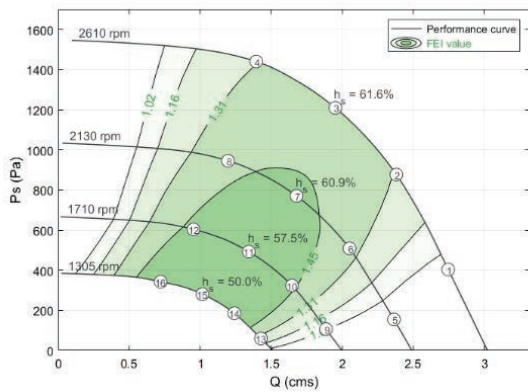

Point	Voltage (V)	Freq (Hz)	Nominal Speed (rpm)	Ps (Pa)	Q (cms)	W (kW)	Hs (%)	I (A)	LwA
1	400	50	2610	404	2.747	3.08	35.9	5.43	102
2	400	50	2610	877	2.382	3.66	57.0	6.51	99
3	400	50	2610	1210	1.952	3.82	61.6	6.62	96
4	400	50	2610	1441	1.395	3.49	57.4	6.10	96
5	400	50	2130	155	2.365	1.61	22.8	3.66	95
6	400	50	2130	509	2.052	1.97	52.9	4.42	92
7	400	50	2130	771	1.679	2.12	60.9	4.65	88
8	400	50	2130	946	1.196	1.97	57.4	4.29	90
9	400	50	1710	107	1.886	0.90	22.4	2.00	91
10	400	50	1710	324	1.647	1.07	49.7	2.24	89
11	400	50	1710	493	1.342	1.15	57.5	2.42	87
12	400	50	1710	604	0.953	1.07	53.8	2.22	87
13	400	50	1305	60	1.428	0.47	18.4	1.05	89
14	400	50	1305	186	1.241	0.54	42.8	1.18	88
15	400	50	1305	281	1.016	0.57	50.0	1.25	88
16	400	50	1305	343	0.721	0.54	46.1	1.18	88

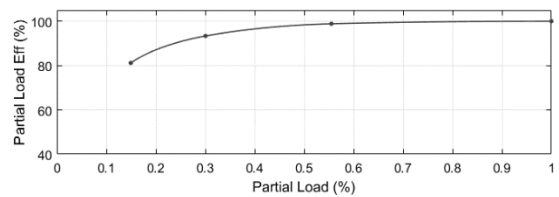
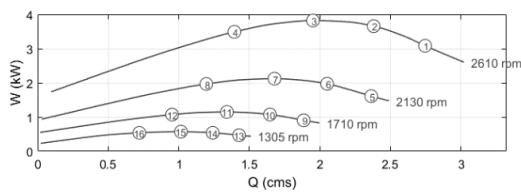

Speed (RPM) shown is nominal. Performance is based on actual speed of test. Ps is static pressure, Q is airflow, W is motor control power input measured, Hs is fan static efficiency, I is input current, LwA is A-weighted outlet sound power. Performance certified is for installation type A-Free Inlet, Free Outlet with partition. Performance ratings do not include the effects of appurtenances (accessories). FE1 values are calculated in accordance with ANSI/AMCA Standard 208 and are based on wire-to-air measurement, (AMCA 211 ratings). The A-weighted sound ratings shown have been calculated per AMCA International Standard 301. Values shown are for outlet LwA sound power levels for installation type A-Free Inlet, Free Outlet with partition. EC motor model number KPMA-80M-3.0-3000 for eBNC 400 LP X. EC motor model number KPMA-80M-4.0-3000 for eBNC 400 MP X.

Ecowatt eBNC 400 HP X – 5.5 kW – 3000

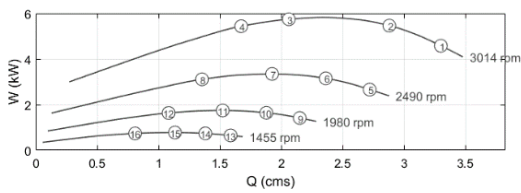
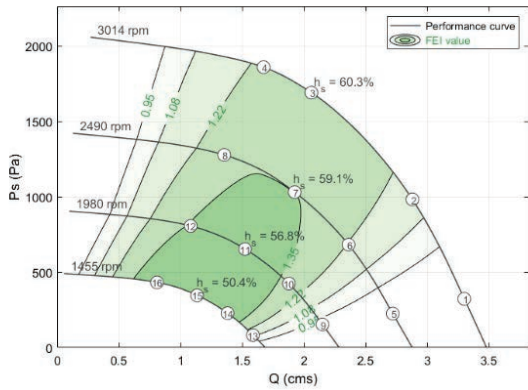

Point	Voltage (V)	Freq (Hz)	Nominal Speed (rpm)	Ps (Pa)	Q (cms)	W (kW)	Hs (%)	I (A)	LwA
1	400	50	3015	323	3.300	4.58	23.3	7.52	106
2	400	50	3014	982	2.880	5.46	51.6	8.86	103
3	400	50	3015	1690	2.061	5.75	60.3	9.27	101
4	400	50	3014	1859	1.673	5.44	56.9	8.97	101
5	400	50	2490	225	2.720	2.66	23.0	4.42	101
6	400	50	2490	682	2.362	3.15	51.0	5.19	98
7	400	50	2490	1030	1.925	3.35	59.1	5.50	95
8	400	50	2490	1277	1.354	3.11	55.4	5.13	95
9	400	50	1980	153	2.150	1.41	23.3	2.45	96
10	400	50	1980	424	1.878	1.64	48.5	2.85	94
11	400	50	1980	653	1.523	1.75	56.8	3.01	92
12	400	50	1980	806	1.082	1.63	53.3	2.82	92
13	400	50	1455	82	1.587	0.65	20.1	1.23	95
14	400	50	1455	228	1.381	0.74	42.8	1.40	94
15	400	50	1455	346	1.134	0.78	50.4	1.53	94
16	400	50	1455	432	0.809	0.74	47.5	1.47	93

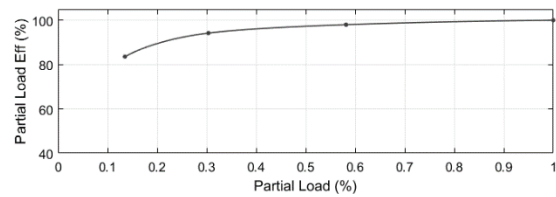

Ecowatt eBNC 450 LP X – 2.2 kW – 1500

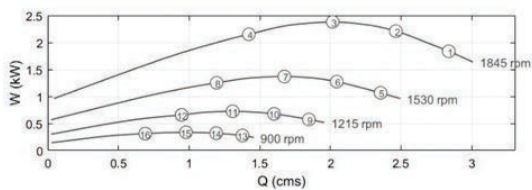
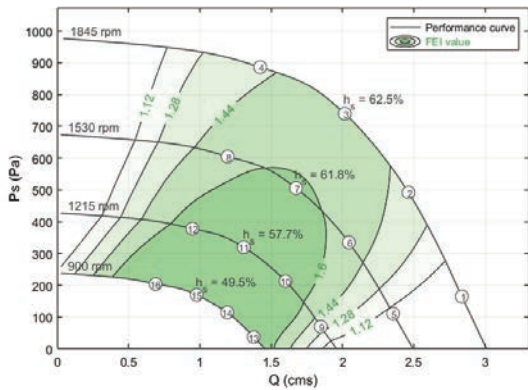

Point	Voltage (V)	Freq (Hz)	Nominal Speed (rpm)	Ps (Pa)	Q (cms)	W (kW)	Hs (%)	I (A)	LwA
1	400	50	1845	165	2.837	1.84	25.5	3.24	96
2	400	50	1845	492	2.463	2.21	54.8	3.91	91
3	400	50	1845	740	2.016	2.38	62.5	4.36	88
4	400	50	1845	886	1.423	2.15	58.5	3.92	89
5	400	50	1530	111	2.355	1.07	24.5	2.17	91
6	400	50	1530	335	2.045	1.27	53.7	2.54	87
7	400	50	1530	506	1.674	1.37	61.8	2.65	84
8	400	50	1530	605	1.195	1.25	57.6	2.42	84
9	400	50	1215	70	1.848	0.57	22.6	1.25	88
10	400	50	1215	213	1.601	0.68	50.2	1.48	87
11	400	50	1215	320	1.308	0.73	57.7	1.60	86
12	400	50	1215	378	0.948	0.66	54.2	1.41	86
13	400	50	900	37	1.378	0.28	18.5	0.51	87
14	400	50	900	115	1.192	0.32	42.8	0.62	86
15	400	50	900	170	0.978	0.34	49.5	0.68	86
16	400	50	900	204	0.690	0.31	45.1	0.64	85

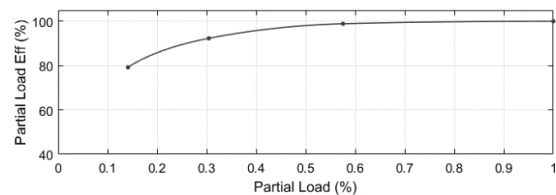

Speed (RPM) shown is nominal. Performance is based on actual speed of test. Ps is static pressure, Q is airflow, W is motor control power input measured, Hs is fan static efficiency, I is input current, LwA is A-weighted outlet sound power. Performance certified is for installation type A-Free Inlet, Free Outlet with partition. Performance ratings do not include the effects of appurtenances (accessories). FEIs values are calculated in accordance with ANSI/AMCA Standard 208 and are based on wire-to-air measurement, (AMCA 211 ratings). The A-weighted sound ratings shown have been calculated per AMCA International Standard 301. Values shown are for outlet LwoA sound power levels for installation type A-Free Inlet, Free Outlet with partition. EC motor model number KPMA-90L-5.5-3000 for eBNC 400 HP X. EC motor model number KPMA-90S-2.2-1500 for eBNC 450 LP X.

Ecowatt eBNC 450 MP X – 5.5 kW – 3000

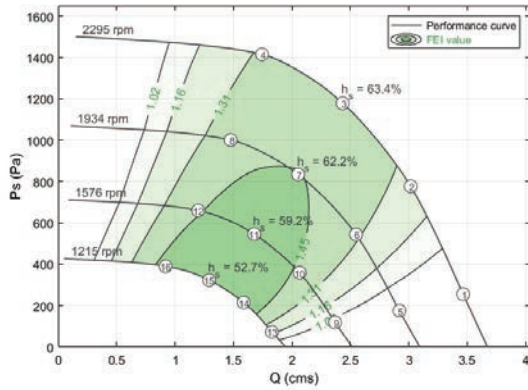

Point	Voltage (V)	Freq (Hz)	Nominal Speed (rpm)	Ps (Pa)	Q (cms)	W (kW)	Hs (%)	I (A)	LwA
1	400	50	2295	255	3.465	3.46	25.5	5.82	100
2	400	50	2295	777	3.016	4.24	55.1	7.13	95
3	400	50	2295	1179	2.434	4.51	63.4	7.43	93
4	400	50	2297	1415	1.744	4.13	59.5	6.84	96
5	400	50	1934	175	2.920	2.11	24.2	3.80	96
6	400	50	1934	544	2.548	2.57	53.9	4.49	92
7	400	50	1934	834	2.053	2.75	62.2	4.76	88
8	400	50	1934	1001	1.476	2.53	58.2	4.54	91
9	400	50	1576	119	2.369	1.21	23.4	2.26	92
10	400	50	1576	359	2.066	1.45	51.2	2.71	89
11	400	50	1576	546	1.677	1.54	59.2	2.91	86
12	400	50	1576	660	1.198	1.43	55.2	2.71	86
13	400	50	1215	72	1.829	0.65	20.4	1.25	91
14	400	50	1215	215	1.587	0.75	45.4	1.45	90
15	400	50	1215	323	1.292	0.79	52.7	1.54	89
16	400	50	1215	390	0.919	0.74	48.5	1.42	89

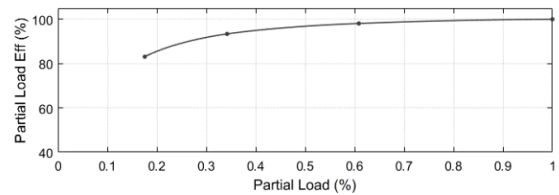
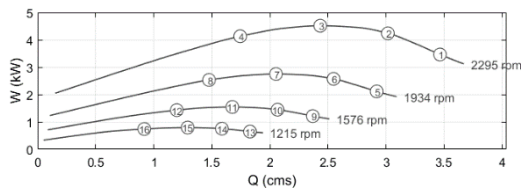

Ecowatt eBNC 450 HP X – 7.5 kW – 3000

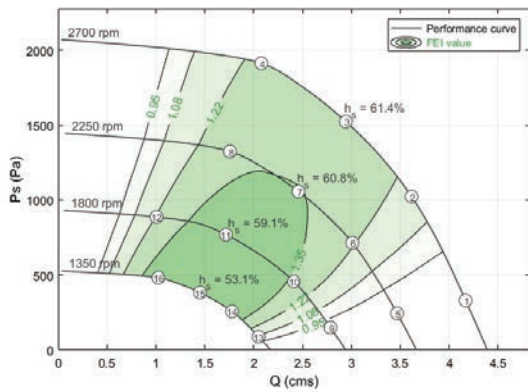

Point	Voltage (V)	Freq (Hz)	Nominal Speed (rpm)	Ps (Pa)	Q (cms)	W (kW)	Hs (%)	I (A)	LwA
1	400	50	2700	330	4.168	5.68	24.2	9.35	105
2	400	50	2700	1024	3.615	6.88	53.6	11.24	101
3	400	50	2700	1524	2.943	7.28	61.4	11.80	98
4	400	50	2700	1914	2.078	6.76	58.5	11.04	99
5	400	50	2250	244	3.467	3.38	25.0	6.54	100
6	400	50	2250	716	3.009	4.05	53.2	7.33	96
7	400	50	2250	1058	2.457	4.26	60.8	7.50	93
8	400	50	2250	1325	1.757	3.99	58.1	7.05	94
9	400	50	1800	149	2.786	1.80	23.0	3.94	95
10	400	50	1800	456	2.412	2.12	51.7	3.74	91
11	400	50	1800	769	1.716	2.23	59.1	4.32	89
12	400	50	1800	888	1.006	1.85	48.3	4.03	91
13	400	50	1350	88	2.050	0.86	20.8	1.85	90
14	400	50	1350	257	1.778	0.99	46.0	2.14	89
15	400	50	1350	383	1.451	1.04	53.1	2.17	88
16	400	50	1350	483	1.025	0.99	50.1	2.17	88

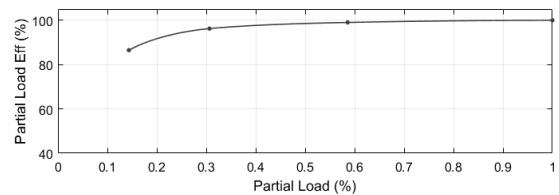
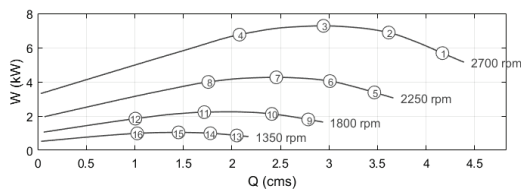

Speed (RPM) shown is nominal. Performance is based on actual speed of test. Ps is static pressure, Q is airflow, W is motor control power input measured, Hs is fan static efficiency, I is input current, LwA is A-weighted outlet sound power. Performance certified is for installation type A-Free Inlet, Free Outlet with partition. Performance ratings do not include the effects of appurtenances (accessories). FEI values are calculated in accordance with ANSI/AMCA Standard 208 and are based on wire-to-air measurement, (AMCA 211 ratings). The A-weighted sound ratings shown have been calculated per AMCA International Standard 301. Values shown are for outlet LwA sound power levels for installation type A-Free Inlet, Free Outlet with partition. EC motor model number KPMA-90L-5.5-3000 for eBNC 450 MP X. EC motor model number KPMA-100L-7.5-3000 for eBNC 450 HP X.

Ecowatt eBNC 500 LP X – 3.0 kW – 1500

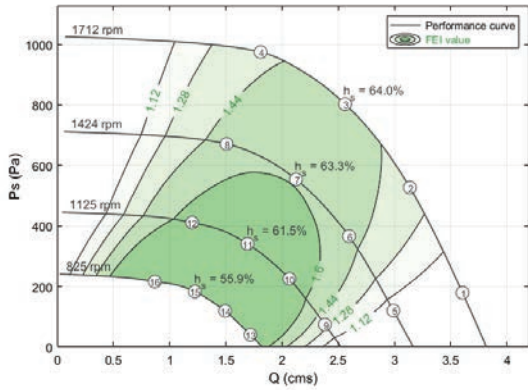

Point	Voltage (V)	Freq (Hz)	Nominal Speed (rpm)	Ps (Pa)	Q (cms)	W (kW)	Hs (%)	I (A)	LwA
1	400	50	1711	179	3.605	2.43	26.5	4.55	97
2	400	50	1712	527	3.137	2.95	55.9	5.34	94
3	400	50	1711	803	2.560	3.20	64.0	6.11	91
4	400	50	1712	975	1.809	2.90	60.7	5.59	88
5	400	50	1424	120	2.990	1.42	25.4	2.84	93
6	400	50	1425	366	2.596	1.72	55.3	3.22	88
7	400	50	1424	554	2.124	1.85	63.3	3.49	85
8	400	50	1424	671	1.506	1.69	59.6	3.49	85
9	400	50	1125	74	2.381	0.73	24.2	1.69	87
10	400	50	1125	225	2.066	0.87	53.3	1.99	85
11	400	50	1125	341	1.692	0.94	61.5	2.11	83
12	400	50	1125	411	1.200	0.86	57.7	1.97	83
13	400	50	825	40	1.719	0.32	21.2	0.82	84
14	400	50	825	119	1.494	0.38	47.2	0.92	83
15	400	50	825	183	1.225	0.40	55.9	0.98	83
16	400	50	825	216	0.868	0.37	51.2	0.90	83

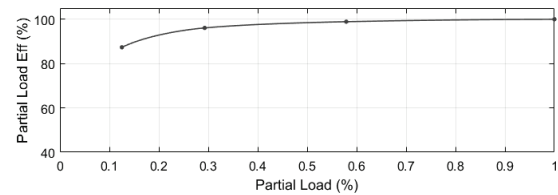
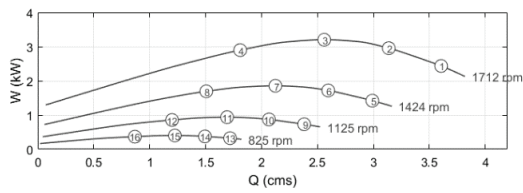

Ecowatt eBNC 500 MP X – 4.0 kW – 1500

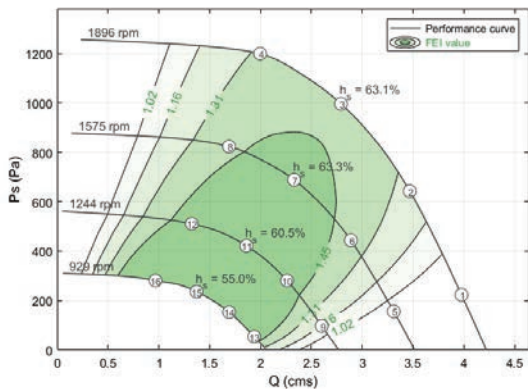

Point	Voltage (V)	Freq (Hz)	Nominal Speed (rpm)	Ps (Pa)	Q (cms)	W (kW)	Hs (%)	I (A)	LwA
1	400	50	1896	223	3.977	3.42	26.0	5.88	99
2	400	50	1896	643	3.468	4.11	54.2	7.02	95
3	400	50	1896	997	2.791	4.40	63.1	7.50	91
4	400	50	1895	1200	1.996	4.02	59.3	6.91	94
5	400	50	1575	156	3.310	1.97	26.1	3.41	96
6	400	50	1575	444	2.889	2.36	54.4	4.08	92
7	400	50	1575	689	2.330	2.53	63.3	4.52	89
8	400	50	1574	824	1.690	2.34	59.3	4.21	90
9	400	50	1244	97	2.602	1.02	24.8	1.91	90
10	400	50	1244	281	2.261	1.22	52.2	2.30	88
11	400	50	1244	422	1.861	1.30	60.5	2.46	86
12	400	50	1244	511	1.324	1.20	56.4	2.29	87
13	400	50	929	54	1.938	0.47	22.3	0.88	86
14	400	50	929	153	1.692	0.55	46.9	1.07	85
15	400	50	929	236	1.371	0.59	55.0	1.18	83
16	400	50	929	281	0.967	0.54	50.2	1.08	83

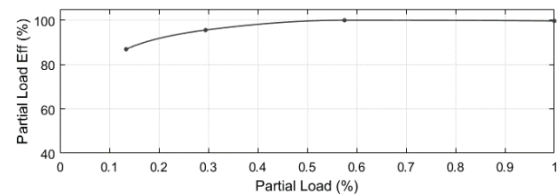
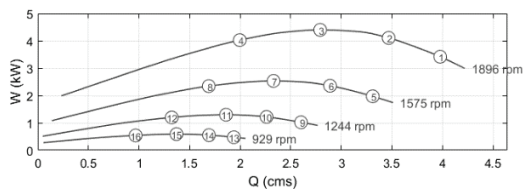

Speed (RPM) shown is nominal. Performance is based on actual speed of test. Ps is static pressure, Q is airflow, W is motor control power input measured, Hs is fan static efficiency, I is input current, LwA is A-weighted outlet sound power. Performance certified is for installation type A-Free Inlet, Free Outlet with partition. Performance ratings do not include the effects of appurtenances (accessories). FEIs values are calculated in accordance with ANSI/AMCA Standard 208 and are based on wire-to-air measurement, (AMCA 211 ratings). The A-weighted sound ratings shown have been calculated per AMCA International Standard 301. Values shown are for outlet LwA sound power levels for installation type A-Free Inlet, Free Outlet with partition. EC motor model number KPMA-90L-3.0-1500 for eBNC 500 LP X. EC motor model number KPMA-100L-4.0-1500 for eBNC 500 MP X.

Ecowatt eBNC 500 HP X – 11.0 kW – 3000

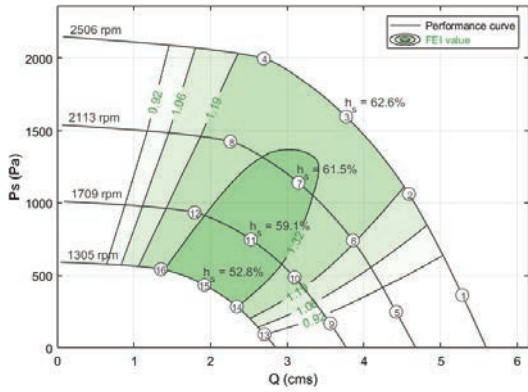

Point	Voltage (V)	Freq (Hz)	Nominal Speed (rpm)	Ps (Pa)	Q (cms)	W (kW)	Hs (%)	I (A)	LwA
1	400	50	2506	364	5.282	7.35	26.1	12.11	108
2	400	50	2506	1062	4.587	8.86	54.8	14.41	103
3	400	50	2506	1597	3.767	9.57	62.6	15.31	100
4	400	50	2506	1997	2.694	8.99	59.5	14.50	104
5	400	50	2113	248	4.420	4.50	24.4	8.29	103
6	400	50	2113	742	3.856	5.38	53.1	9.76	99
7	400	50	2113	1140	3.146	5.82	61.5	10.22	96
8	400	50	2113	1424	2.259	5.48	58.5	9.63	99
9	400	50	1709	168	3.562	2.51	23.8	5.26	100
10	400	50	1709	487	3.096	2.95	50.9	5.45	97
11	400	50	1709	748	2.525	3.19	59.1	6.37	94
12	400	50	1709	934	1.792	3.01	55.5	5.99	95
13	400	50	1304	93	2.702	1.28	19.7	2.52	92
14	400	50	1305	285	2.343	1.48	45.2	2.91	90
15	400	50	1305	434	1.920	1.58	52.8	3.11	89
16	400	50	1304	543	1.353	1.49	49.2	2.88	89

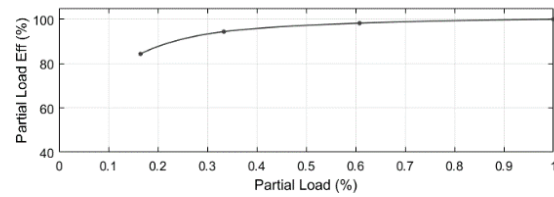
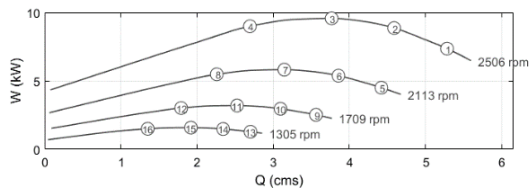

Ecowatt eBNC 560 LP X – 5.5 kW – 3000

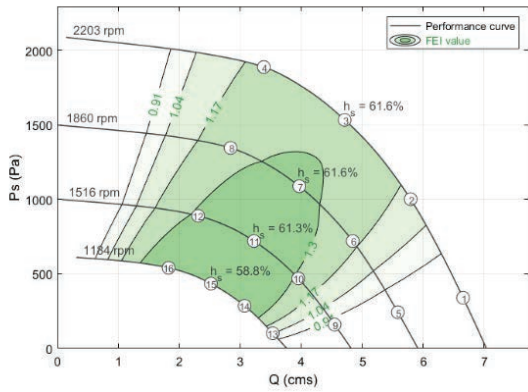

Point	Voltage (V)	Freq (Hz)	Nominal Speed (rpm)	Ps (Pa)	Q (cms)	W (kW)	Hs (%)	I (A)	LwA
1	400	50	1665	203	5.083	4.04	25.6	7.08	100
2	400	50	1665	608	4.431	4.88	55.1	8.56	96
3	400	50	1665	935	3.600	5.24	64.0	9.20	92
4	400	50	1665	1130	2.570	4.80	60.3	8.37	94
5	400	50	1443	152	4.445	2.68	25.2	5.06	96
6	400	50	1443	462	3.870	3.23	55.4	6.07	92
7	400	50	1443	712	3.127	3.47	64.0	6.38	88
8	400	50	1443	858	2.188	3.15	59.5	5.87	89
9	400	50	1140	95	3.484	1.32	25.2	2.32	91
10	400	50	1140	289	3.018	1.59	54.7	2.90	88
11	400	50	1140	434	2.467	1.70	62.8	3.08	86
12	400	50	1140	524	1.757	1.57	58.5	2.90	87
13	400	50	838	64	2.584	0.62	26.4	1.36	87
14	400	50	838	165	2.249	0.72	51.2	1.59	85
15	400	50	838	241	1.850	0.77	58.2	1.69	84
16	400	50	838	289	1.324	0.70	54.4	1.57	84

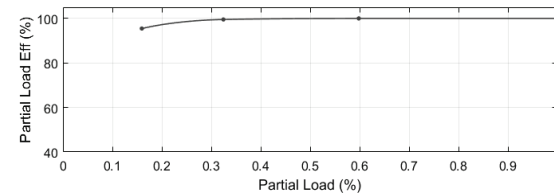
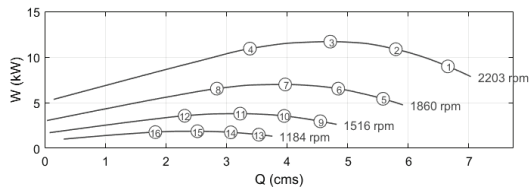

Speed (RPM) shown is nominal. Performance is based on actual speed of test. Ps is static pressure, Q is airflow, W is motor control power input measured, Hs is fan static efficiency, I is input current, LwA is A-weighted outlet sound power. Performance certified is for installation type A-Free Inlet, Free Outlet with partition. Performance ratings do not include the effects of appurtenances (accessories). FEIs values are calculated in accordance with ANSI/AMCA Standard 208 and are based on wire-to-air measurement, (AMCA 211 ratings). The A-weighted sound ratings shown have been calculated per AMCA International Standard 301. Values shown are for outlet LwA sound power levels for installation type A-Free Inlet, Free Outlet with partition. EC motor model number KPMA-100L-11.0-3000 for eBNC 500 HP X. EC motor model number KPMA-100L-5.5-1500 for eBNC 560 LP X.

Ecowatt eBNC 560 MP X – 7.5 kW – 1500

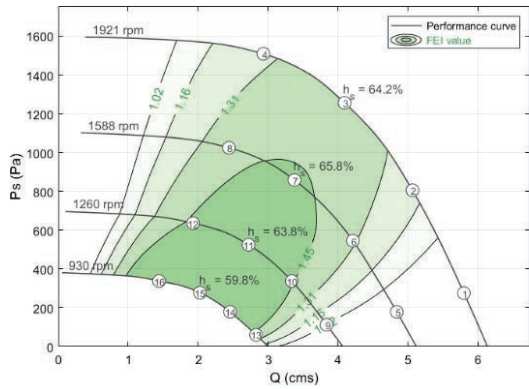

Point	Voltage (V)	Freq (Hz)	Nominal Speed (rpm)	Ps (Pa)	Q (cms)	W (kW)	Hs (%)	I (A)	LwA
1	400	50	1921	276	5.803	6.21	25.8	10.07	104
2	400	50	1920	806	5.067	7.45	54.7	12.11	99
3	400	50	1923	1256	4.096	7.99	64.2	12.79	96
4	400	50	1920	1509	2.935	7.28	60.6	11.70	98
5	400	50	1588	179	4.843	3.41	25.4	6.09	99
6	400	50	1587	546	4.215	4.10	56.0	7.25	96
7	400	50	1589	859	3.379	4.40	65.8	7.51	92
8	400	50	1587	1025	2.442	4.03	61.9	6.88	93
9	400	50	1259	113	3.839	1.75	24.8	3.26	95
10	400	50	1259	338	3.341	2.08	54.3	3.90	92
11	400	50	1260	525	2.723	2.24	63.8	4.22	88
12	400	50	1259	636	1.930	2.05	59.9	3.85	88
13	400	50	930	61	2.831	0.74	23.2	1.45	89
14	400	50	930	179	2.459	0.88	50.3	1.73	88
15	400	50	930	278	2.028	0.94	59.8	1.84	86
16	400	50	930	338	1.443	0.87	55.8	1.70	86

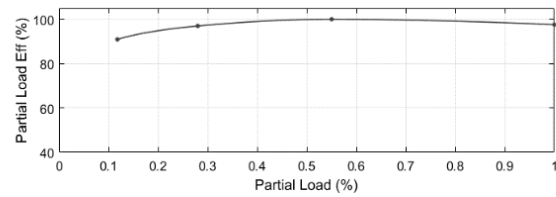
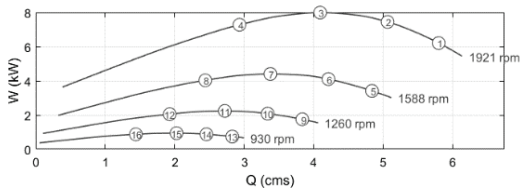

Ecowatt eBNC 560 HP X – 15.0 kW – 3000

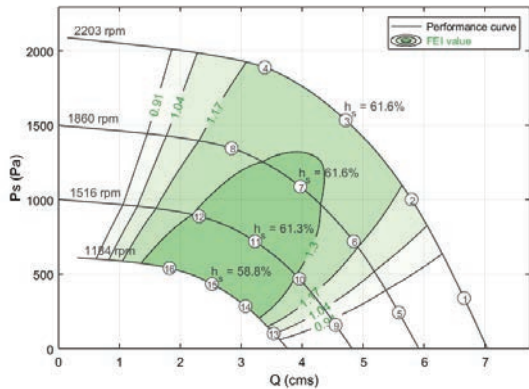

Point	Voltage (V)	Freq (Hz)	Nominal Speed (rpm)	Ps (Pa)	Q (cms)	W (kW)	Hs (%)	I (A)	LwA
1	400	50	2203	340	6.656	8.98	25.2	14.51	108
2	400	50	2203	1002	5.796	10.86	53.3	17.62	105
3	400	50	2203	1534	4.715	11.69	61.6	18.04	103
4	400	50	2203	1889	3.388	10.92	58.3	16.98	104
5	400	50	1860	243	5.586	5.42	25.1	8.99	103
6	400	50	1860	721	4.846	6.53	53.4	10.65	100
7	400	50	1860	1089	3.970	6.99	61.6	11.52	98
8	400	50	1860	1346	2.843	6.54	58.4	10.51	99
9	400	50	1516	160	4.550	2.96	24.6	5.13	100
10	400	50	1516	470	3.954	3.54	52.4	6.06	97
11	400	50	1516	721	3.227	3.79	61.3	6.47	94
12	400	50	1516	890	2.312	3.56	57.6	6.02	94
13	400	50	1184	102	3.535	1.49	24.3	2.71	92
14	400	50	1183	286	3.073	1.75	50.4	3.15	90
15	400	50	1183	435	2.521	1.87	58.8	3.42	87
16	400	50	1183	541	1.827	1.77	55.8	3.18	87

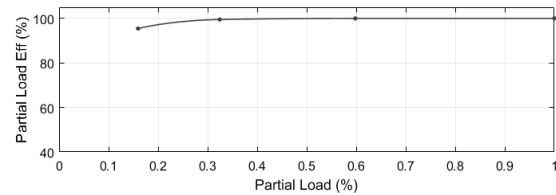
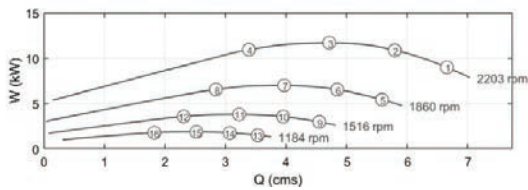

Speed (RPM) shown is nominal. Performance is based on actual speed of test. Ps is static pressure, Q is airflow, W is motor control power input measured, Hs is fan static efficiency, I is input current, LwA is A-weighted outlet sound power. Performance certified is for installation type A-Free Inlet, Free Outlet with partition. Performance ratings do not include the effects of appurtenances (accessories). FEIs values are calculated in accordance with ANSI/AMCA Standard 208 and are based on wire-to-air measurement, (AMCA 211 ratings). The A-weighted sound ratings shown have been calculated per AMCA International Standard 301. Values shown are for outlet LwA sound power levels for installation type A-Free Inlet, Free Outlet with partition. EC motor model number KPMA-112M-7.5-1500 for eBNC 500 LP X. EC motor model number KPMA-112M-15.0-3000 for eBNC 560 HP X.

Ecowatt eBNC 630 LP X – 5.5 kW – 1500

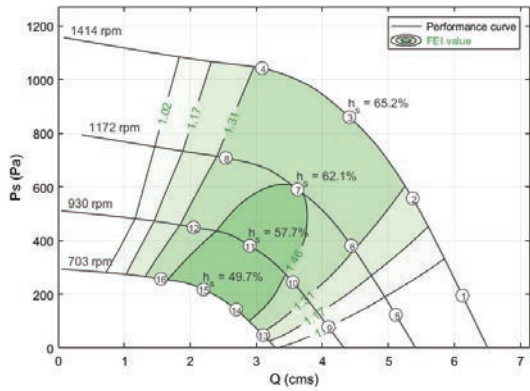

Point	Voltage (V)	Freq (Hz)	Nominal Speed (rpm)	Ps (Pa)	Q (cms)	W (kW)	Hs (%)	I (A)	LwA
1	400	50	1415	195	6.123	4.58	26.1	7.62	98
2	400	50	1414	557	5.370	5.44	54.9	8.93	95
3	400	50	1414	860	4.410	5.80	65.2	9.34	93
4	400	50	1415	1042	3.087	5.29	60.7	8.66	95
5	400	50	1172	123	5.114	2.74	23.0	5.25	95
6	400	50	1172	381	4.439	3.24	52.2	6.04	93
7	400	50	1172	591	3.624	3.44	62.1	6.49	90
8	400	50	1172	708	2.538	3.15	57.0	5.93	93
9	400	50	930	78	4.093	1.55	20.6	2.93	88
10	400	50	930	245	3.555	1.80	48.3	3.26	86
11	400	50	930	381	2.902	1.91	57.7	3.75	85
12	400	50	930	449	2.051	1.76	52.1	3.54	85
13	400	50	703	48	3.106	0.82	18.3	1.70	88
14	400	50	703	143	2.697	0.92	41.7	1.91	88
15	400	50	703	218	2.201	0.97	49.7	2.01	88
16	400	50	703	257	1.556	0.90	44.2	1.86	88

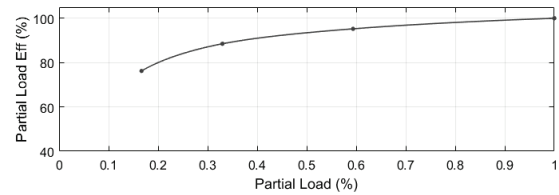
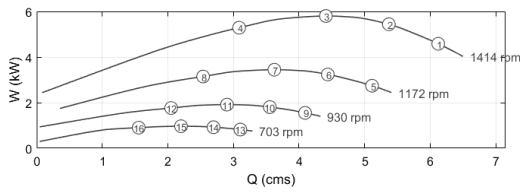

Ecowatt eBNC 630 MP X – 7.5 kW – 1500

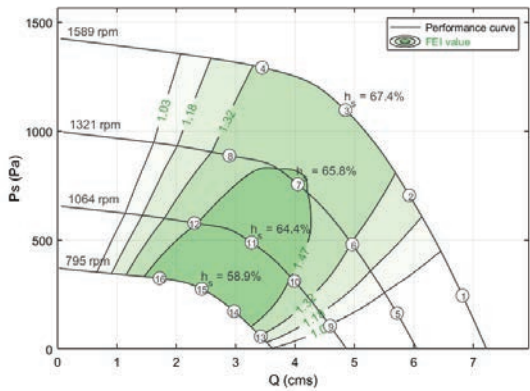

Point	Voltage (V)	Freq (Hz)	Nominal Speed (rpm)	Ps (Pa)	Q (cms)	W (kW)	Hs (%)	I (A)	LwA
1	400	50	1588	245	6.825	6.15	27.2	10.52	102
2	400	50	1589	705	5.930	7.39	56.5	12.56	99
3	400	50	1589	1097	4.853	7.87	67.4	12.90	97
4	400	50	1589	1292	3.451	7.04	63.1	11.56	97
5	400	50	1321	164	5.722	3.64	25.7	6.34	97
6	400	50	1321	480	4.969	4.35	54.8	7.52	94
7	400	50	1321	756	4.051	4.65	65.8	8.09	91
8	400	50	1321	888	2.900	4.20	61.2	7.18	91
9	400	50	1063	106	4.595	1.97	24.7	3.61	92
10	400	50	1064	311	3.995	2.32	53.5	4.25	90
11	400	50	1064	489	3.272	2.48	64.4	4.56	88
12	400	50	1064	578	2.309	2.24	59.4	4.12	88
13	400	50	795	57	3.428	0.92	21.2	1.73	87
14	400	50	795	173	2.980	1.07	48.1	2.02	86
15	400	50	795	275	2.433	1.14	58.9	2.19	85
16	400	50	795	325	1.726	1.04	53.9	1.97	85

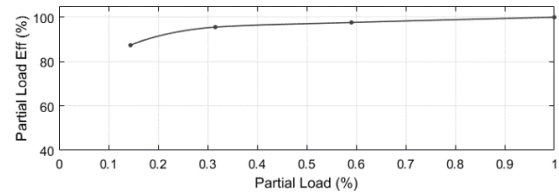
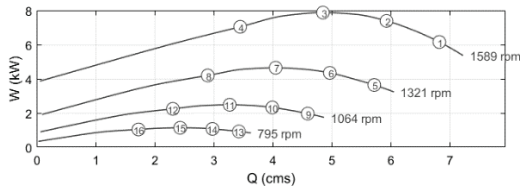

Speed (RPM) shown is nominal. Performance is based on actual speed of test. Ps is static pressure, Q is airflow, W is motor control power input measured, Hs is fan static efficiency, I is input current, LwA is A-weighted outlet sound power. Performance certified is for installation type A-Free Inlet, Free Outlet with partition. Performance ratings do not include the effects of appurtenances (accessories). FETs values are calculated in accordance with ANSI/AMCA Standard 208 and are based on wire-to-air measurement, (AMCA 211 ratings). The A-weighted sound ratings shown have been calculated per AMCA International Standard 301. Values shown are for outlet LwA sound power levels for installation type A-Free Inlet, Free Outlet with partition. EC motor model number KPMA-100L-5.5-1500 for eBNC 630 LP X. EC motor model number KPMA-112M-7.5-1500 for eBNC 630 MP X.

Ecowatt eBNC 630 HP X – 11.0 kW – 1500

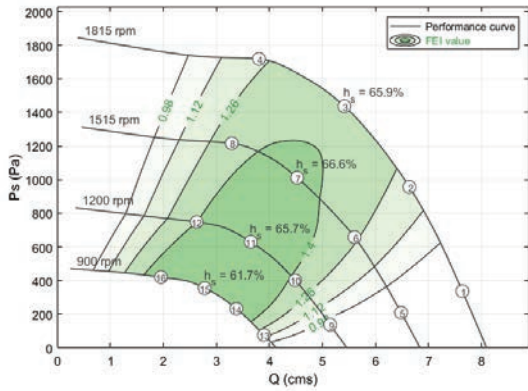

Point	Voltage (V)	Freq (Hz)	Nominal Speed (rpm)	P _s (Pa)	Q (cms)	W (kW)	H _s (%)	I (A)	LwA
1	400	50	1815	337	7.639	9.32	27.6	14.54	104
2	400	50	1815	957	6.641	11.18	56.7	17.64	103
3	400	50	1815	1437	5.415	11.76	65.9	18.55	103
4	400	50	1815	1719	3.805	10.88	59.9	17.21	103
5	400	50	1515	210	6.484	5.40	25.2	9.03	97
6	400	50	1515	659	5.606	6.50	56.7	10.83	94
7	400	50	1515	1012	4.524	6.85	66.6	11.41	94
8	400	50	1515	1217	3.291	6.40	62.4	10.58	95
9	400	50	1200	138	5.146	2.79	25.4	4.76	93
10	400	50	1200	402	4.486	3.30	54.6	5.54	90
11	400	50	1200	631	3.650	3.50	65.7	5.85	87
12	400	50	1200	749	2.630	3.26	60.3	5.52	87
13	400	50	900	77	3.898	1.30	23.3	2.31	85
14	400	50	900	233	3.378	1.52	51.9	2.77	83
15	400	50	900	355	2.781	1.60	61.7	2.96	82
16	400	50	900	421	1.957	1.47	56.2	2.69	82

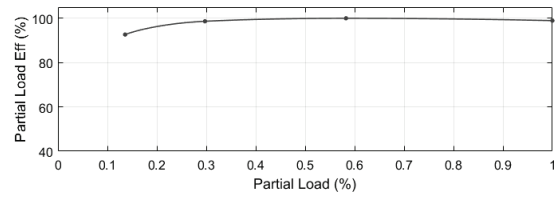
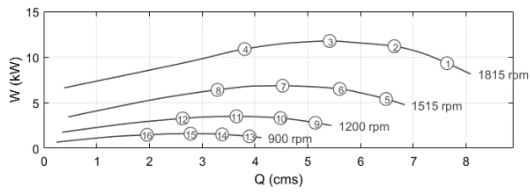

Speed (RPM) shown is nominal. Performance is based on actual speed of test. P_s is static pressure, Q is airflow, W is motor control power input measured, H_s is fan static efficiency, I is input current, LwA is A-weighted outlet sound power. Performance certified is for installation type A-Free Inlet, Free Outlet with partition. Performance ratings do not include the effects of appurtenances (accessories). FEl's values are calculated in accordance with ANSI/AMCA Standard 208 and are based on wire-to-air measurement, (AMCA 211 ratings). The A-weighted sound ratings shown have been calculated per AMCA International Standard 301. Values shown are for outlet LwA sound power levels for installation type A-Free Inlet, Free Outlet with partition. EC motor model number KPMA-132S-11.0-1500 for eBNC 630 HP X

Power & Control Wiring



The following section shows an overview of connection for power and control .

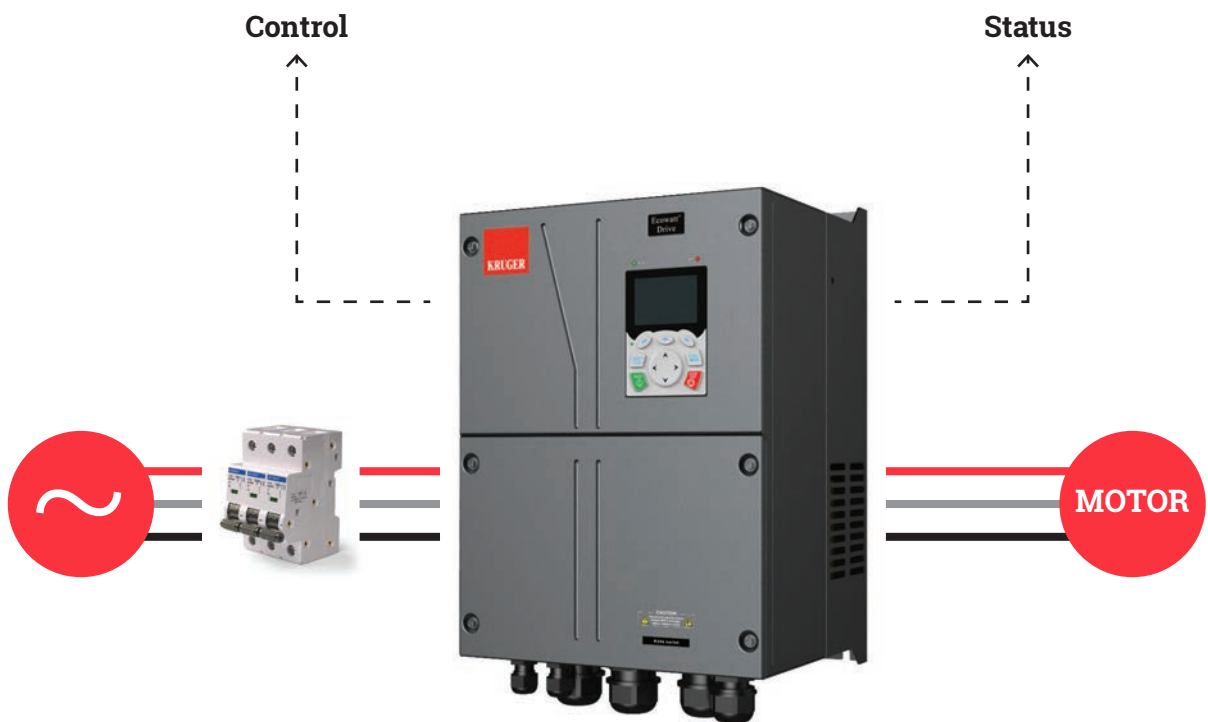

Figure 1 Overall Connection

Power Wiring

- Refer to the eBNC-X product specific operating instructions for safety guidelines and recommended cable size when connecting power wiring.
- Shielded cables are not required for use on power cables.
- Where multiple fans are installed in one AHU, individual circuit breakers must be installed for each fan.
- Three-phase main power must be connected, do not use the output from a variable speed drive to power an eBNC -X

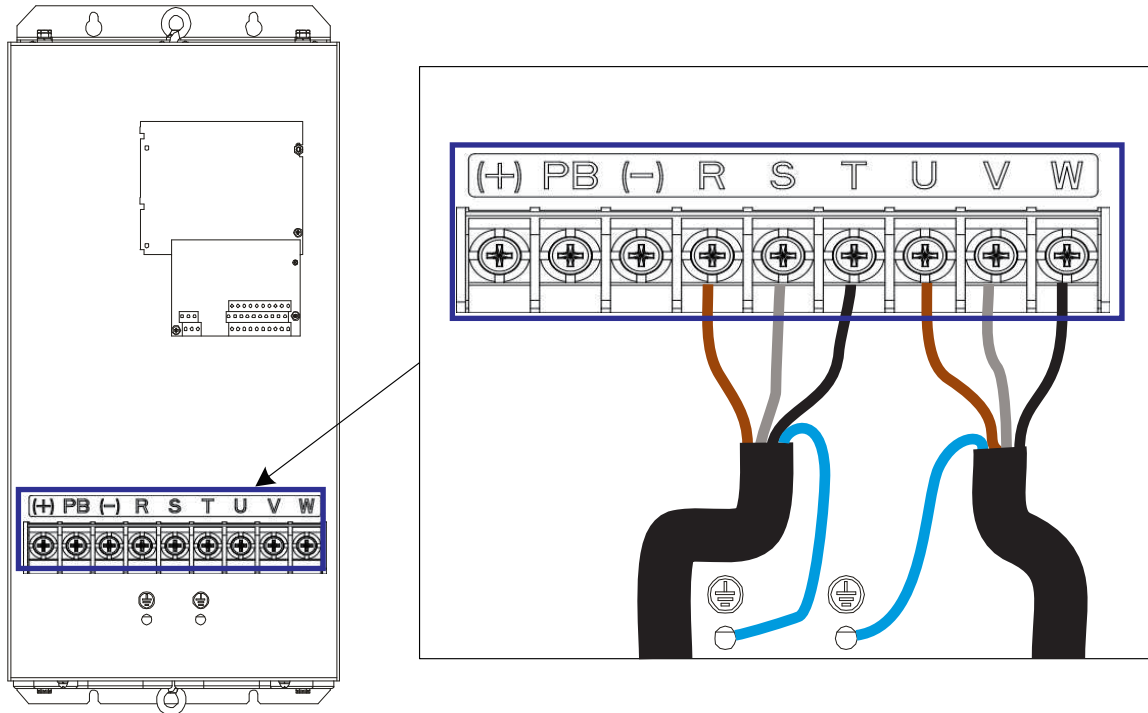

Figure 2 Power Wiring

VFD Model	Recommended Cable size (mm)			Breaker Rated Current (A)	Fixing screw	
	R U V W	PE	PB (+) (-)		Terminal Screw Specification	Tightening torque (Nm)
K354-5R5P-4	1.5	1.5	1.5	25	M5	2-2.5
K354-7R5P-4	2.5	2.5	2.5	32	M5	2-2.5
K354-011P-4	4	4	4	50	M5	2-2.5
K354-015P-4	6	6	6	63	M5	2-2.5
K354-018P-4	10	10	10	63	M6	4-6

Table 1 Shown Cable Size Recommend

Control Wiring

There are 3 different methods to control the speed functions:

1. Manual speed control by using Potentiometer: Analog signal 0–10Vdc.
2. Automatic speed control by using Demand Controlled Ventilation (DCV)
3. Automatic speed control using eBNC-X Modbus RTU interface PC program: RS485 digital port.
Please contact Kruger to get a training about eBNC-X Modbus RTU interface PC program and configurations method.

When wiring, please consider the following:

- Refer to the eBNC-X product specific operating instructions for safety guidelines and recommend cable size when connecting control wiring.
- Shielded cables are not r Ensure that the RSA, RSB, 0-10V input, +10V output and ground of each fan are accessible at an external location away from the three phase power supply connections.
- Where MODBUS over RS485 is used, appropriate shielded cable should be used.

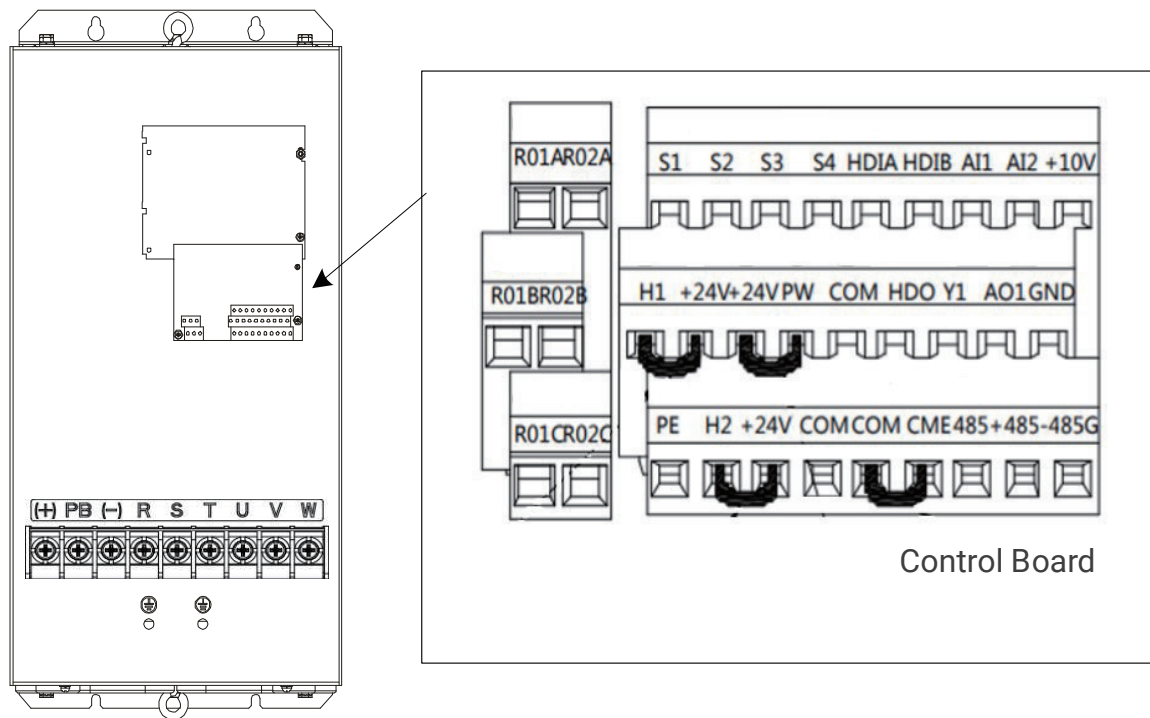
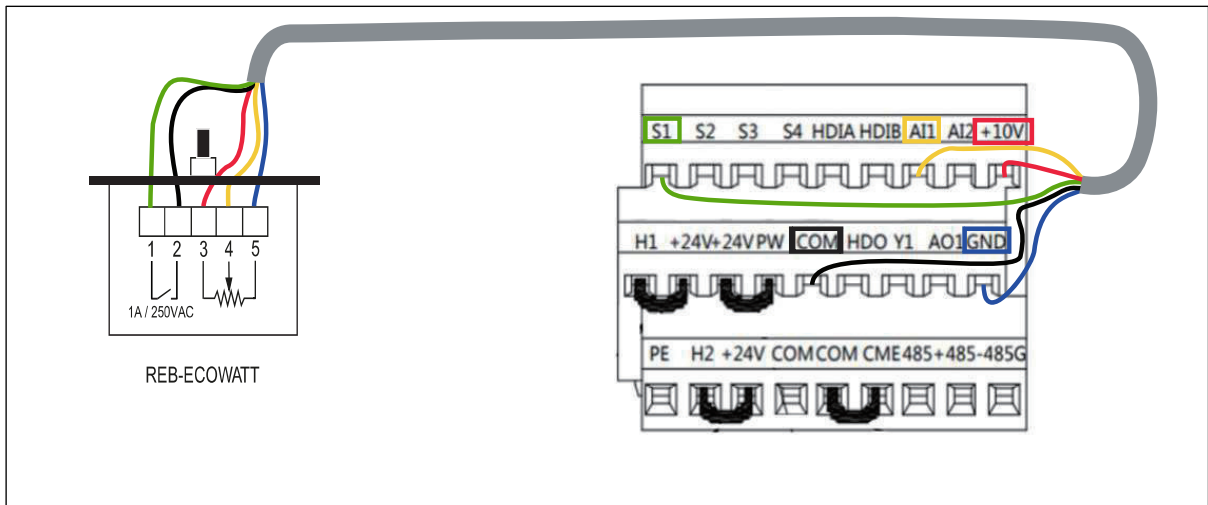

Figure 3 Control Wiring

Terminal	Description
+10V	Locally provided +10.5V power
AI1	<ul style="list-style-type: none"> • Input range: All voltage/current can choose 0-10/ 0-20mA; • Input impedance: 20kΩ during voltage input; 250 Ω during current input; • All voltage or current input is set by P05.50; • Resolution ratio: When 10V corresponds to 50Hz, the min. resolution ratio is 5mV; • 25°C, When input above 5V or 10mA, the error is ±0.5%
GND	+10.5V reference zero potential
RO1A	<ul style="list-style-type: none"> • RO relay output; ROA is NO, ROB is NC, ROC is common port • Contact capacity: 3A/AC250V, 1A/DC30V
RO1B	
RO1C	
RO2A	
RO2B	
RO2C	
COM	Common port of +24V
485+	RS485 differential signal port and standard RS485 communication port must use twisted shielded pair; the 120ohm terminal matching resistor of RS485 communication
485-	

Table 2 Explanation Terminal Name

1. Potentiometer



2. 0-10V and 4-20mA Control

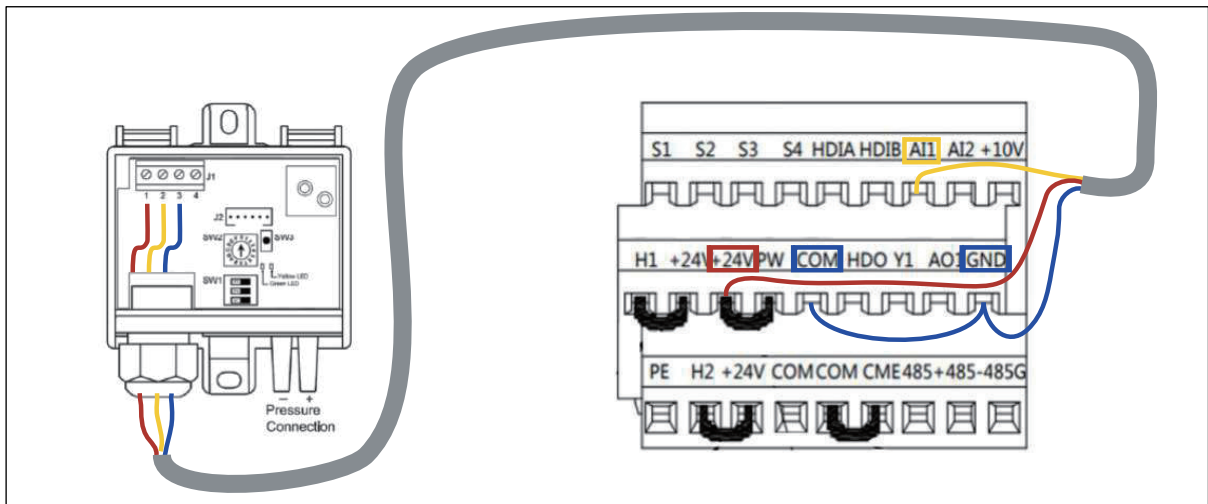

3. Modbus Control

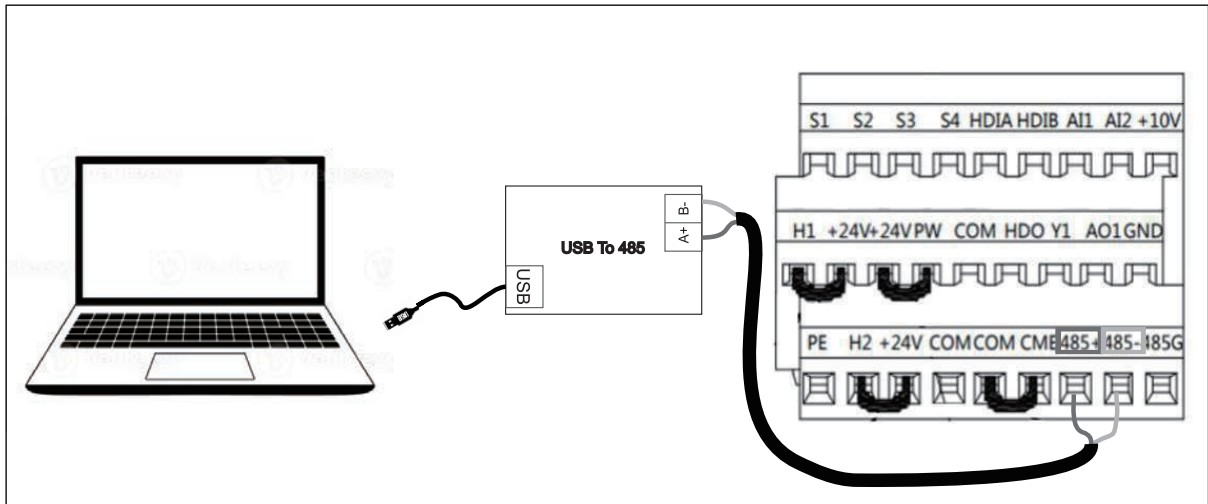

Status Relay

- Status relay should be connected to show the status of fan motor operation.
- When stop operation the R01B – R01C will be short circuit.
- When run operation the R01A – R01C will be short circuit.
- When fault operation the R02A – R02C will be short circuit.
 - overcurrent
 - overvoltage
 - undervoltage
 - over-temperature
 - etc

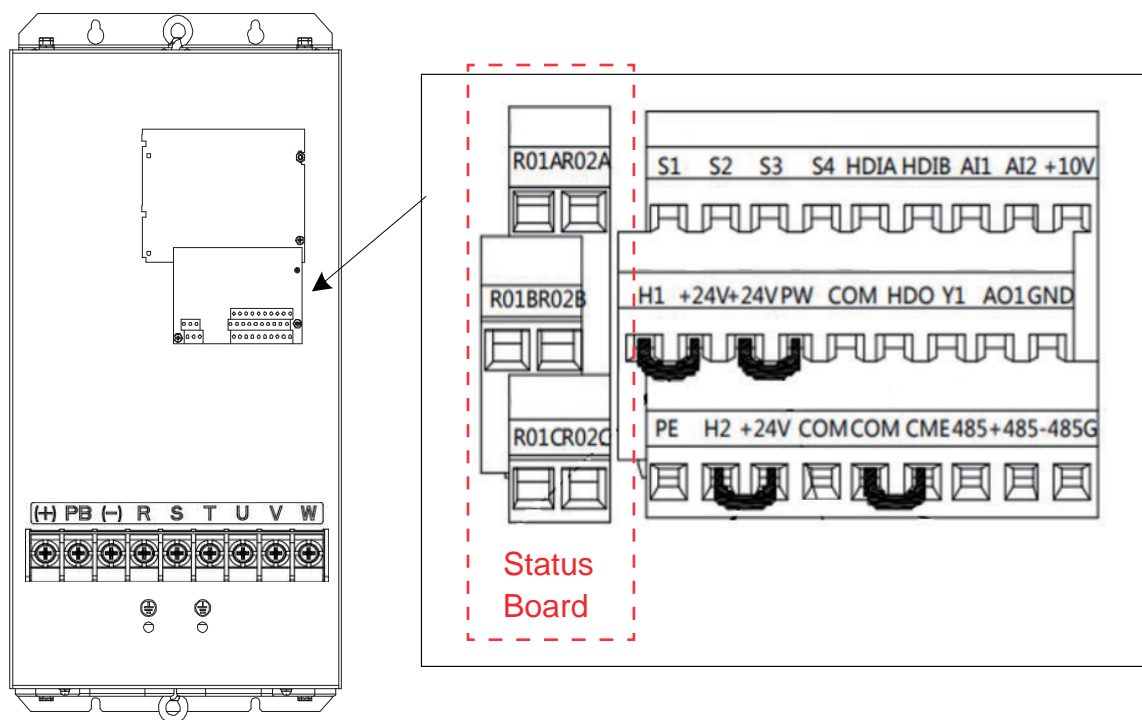
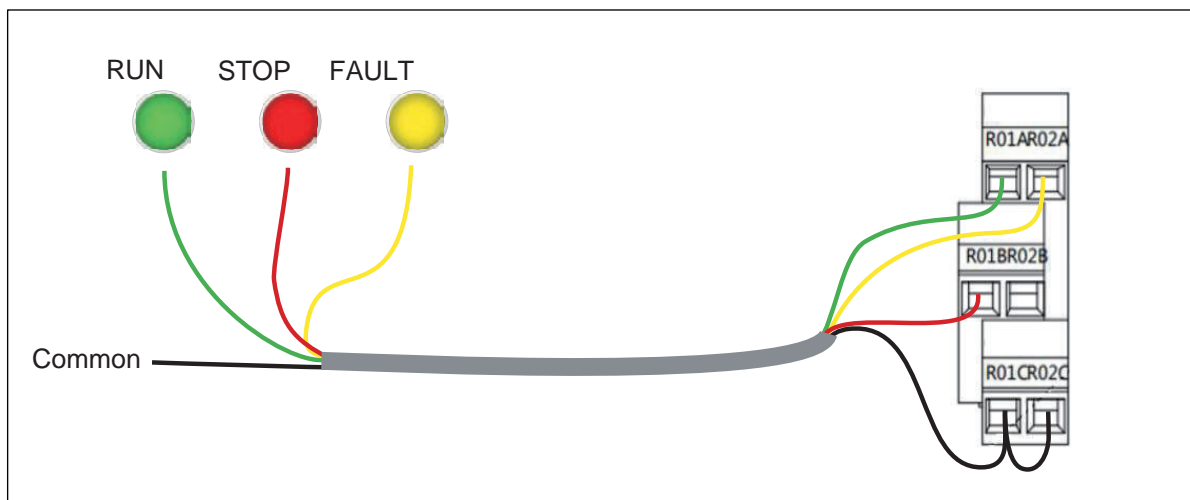

Figure 4 Relay Status



KRUGER Ventilation Group

THAILAND (REGIONAL HEADQUARTER)

KRUGER VENTILATION INDUSTRIES ASIA CO., LTD.
30/159 Moo 1, Sinsakorn Industrial Estate, Chetsadawithi Road,
Khok Kham Mueng, Samuthsakorn 74000, Thailand
Tel: +662 1054298 Fax: +662 0248256-9
Website: www.krugerfan.com

THAILAND

KRUGER VENTILATION IND. (THAILAND) CO., LTD.
30/105 Moo 1, Sinsakorn Industrial Estate, Chetsadawithi
Road, Khok Kham Mueng, Samuthsakorn 74000, Thailand
Tel: +662 1050399 Fax: +662 1050370-2
Email: mktg@kruger.co.th

INDIA

KRUGER VENTILATION INDUSTRIES (INDIA) PVT. LTD.
Kruher Centre, Mumbai-Nasik Highway, Kalamgaon,
Shahapur, Thane 421601, Maharashtra, India
Tel: +91 9960558899/9975577211
Email: sales@krugerindia.com

INDIA (NORTH)

KRUGER VENTILATION INDUSTRIES (INDIA) PVT. LTD.
Khasra No. 150//20/2/1, 21/1/2, 22/2, 151//16/2/2, Village
Rohad, Tehsil Bahadurgarh, Jhajar, Haryana-124507, India
Tel: +91-9958991652/9958991660/8586966303
Fax: +91-1276-278096
Email: sales.kni@krugerindia.com, service@krugerindia.com

KOREA

NEOMATE CO., LTD.
2-1010, Ace High Tech City B/D, 775 Gyeongin-ro,
Yeongdeungpo-gu, Seoul, Korea. Postal Code 07299
Tel: +82-2-2679-2052 Fax: +82-2-2679-2174
Email: y7890@neomate.co.kr

SINGAPORE

KRUGER ENGINEERING PTE. LTD.
2 Venture Drive #20-23, Vision Exchange,
Singapore 608526.
Tel: +65 68631191 Fax: +65 68631151
Email: mktg@krugerfan.com

AUSTRALIA

S&P KRUGER AUSTRALIA PTY. LTD.
2 Cunningham St, Moorebank N.S.W. 2170
Tel: +61 2-98227747
Fax: +61 2-98227757
Email: info@sandpkruger.com.au

INDONESIA

PT. KRUGER VENTILATION INDONESIA.
JL. Teuku Umar No.20, RT. 001/RW. 001.
Karawaci, Tangerang 15115, Indonesia
Tel: +62 21-5512288/5513557/5513576/5514353
Fax: +62 21-5513502
Email: mktg@krugerindo.co.id

VIETNAM

KRUGER VENTILATION INDUSTRIES (VIETNAM) CO., LTD.
Lot A7. 2-4, C2 Road, Thanh Thanh Cong IZ,
Trang Bang Dist. Tay Ninh Province, Vietnam
Tel: +84-276 3585200/01/02 Fax: +84-276 3585199
Email: mktg@krugervn.com

CHINA (GUANGZHOU)

GUANGZHOU KRUGER VENTILATION CO., LTD.
No. 9 Huahui Road, Huashan, Huadu,
Guangzhou, P.R. China 510880
Tel: +86 20-66356635 Fax: +86 20-86786001/86786500
Email: gzkruger@krugergz.com

CHINA (TIANJIN)

TIANJIN KRUGER VENTILATION CO., LTD.
Jingjin Science and Technology Park
Wuqing District, Tianjin, China
Tel: +86 22-22143480/3481 Fax: +86 22-22143482
Email: krugertj@krugertj.com

CHINA (SHANGHAI)

SHANGHAI KRUGER VENTILATION CO., LTD.
No.500 Yuanguo Road, Anting, Jiading District,
Shanghai 201814, P.R. China
Tel: +86 21-69573266 Fax: +86 21-69573296
Email: shkruger@krugerchina.com

CHINA (WUHAN)

WUHAN KRUGER VENTILATION CO., LTD.
No. 805, Huian Ave, Dongxihu District, Wuhan,
Hubei, P.R. China 430040
Tel: +86 27- 83248840/83060522/83097505
Fax: +86 27- 83261886
Email: whkruger@krugerwh.com

HONG KONG

KRUGER VENTILATION (HONG KONG) LIMITED.
Flat C, 9/F, Yeung Yiu Chung (No.8) Industrial Building,
20 Wang Hoi Road, Kowloon Bay, Kowloon, Hong Kong
Tel: +852 22469182 Fax: +852 22469187
Email: info@kruger.com.hk

TAIPEI

KRUGER VENTILATION (TAIWAN) CO., LTD.
No. 157, Ping-an Rd, Hengfeng Village, Dayuan Shiang
Taoyuan County 337, Taiwan
Tel: +886 3-3859119 Fax: +886 3-3859118
Email: sales@krugertwn.com.tw

MALAYSIA

KRUVENT INDUSTRIES (M) SDN. BHD.
Lot 850, Jalan Subang 7, Taman Perindustrian
Subang, 47500, Subang Jaya, Selangor D.E.
Tel: +603 80743399 Fax: +603 80743388
Email: mktg@kruger.com.my

PHILIPPINES

KRUGER M & E INDUSTRIES CORP.
B3 Welborne Industrial Park, Bancal,
Carmona, Cavite, Philippines 4116
Tel: +63-917 561 9088, +63-917 596 7288
+63-917 712 8438, +63-917 306 8288
Email: mktg@krugerph.net

A member of



Kruger Ventilation Industries Asia Co., Ltd

30/159 Moo 1, Sinsakorn Industrial Estate
Chetsadawithi Road, Khok Kham Mueng,
Samuthsakorn 74000, Thailand
Tel. +662 1054298 - Fax. +662 0248256-9
Website: www.krugerfan.com

CNo. - CAT166.E0.ED1 June 2024

A member of

